

Deutsche Bank



Investors Bus Tour

October 7, 2021



Teck

Caution Regarding Forward-Looking Statements

Both these slides and the accompanying oral presentations contain certain forward-looking statements within the meaning of the United States Private Securities Litigation Reform Act of 1995 and forward-looking information within the meaning of the Securities Act (Ontario) and comparable legislation in other provinces (collectively referred to herein as forward-looking statements). Forward-looking statements can be identified by the use of words such as “plans”, “expects” or “does not expect”, “is expected”, “budget”, “scheduled”, “estimates”, “forecasts”, “intends”, “anticipates” or “does not anticipate”, or “believes”, or variation of such words and phrases or state that certain actions, events or results “may”, “could”, “should”, “would”, “might” or “will” be taken, occur or be achieved. Forward-looking statements involve known and unknown risks, uncertainties and other factors which may cause the actual results, performance or achievements of Teck to be materially different from any future results, performance or achievements expressed or implied by the forward-looking statements. These statements speak only as of the original date of this presentation.

These forward-looking statements include, but are not limited to, statements concerning: the potential impact of the COVID-19 on our business and operations, including our ability to continue operations at our sites; our ability to manage challenges presented by COVID-19; our long-term strategy, including but not limited to copper growth strategy; doubling of copper production by 2023 through QB2; all expectations regarding future copper, zinc and steelmaking coal demand and how Teck is positioned to benefit; Teck’s strategy ensuring we are well-positioned for changes in demand for commodities; expectation that Teck is well positioned for the low-carbon economy; our goal of carbon neutrality and the steps to achieve that goal; expectations of copper production growth; our copper growth strategy and the components of that strategy, including but not limited to accelerating growth in copper, and maximizing cash flow from operations to fund copper growth; our climate action strategy and goals; all projections and forecasts about QB2 and QB3 or based on QB2 or QB3, including but not limited to life of the deposit, copper growth, C1 cash costs and AISC costs, strip ratio, throughput rate and potential to become a top five global copper producer, reserve and resource estimates, first production expectation, and all other projections included in the “Quebrada Blanca 2” Appendix; statement that Teck is positioned to realize value from a robust pipeline of copper projects; our ability to develop our copper growth projects; expectation that our copper growth projects will be approved for development; all potential project economics of our copper projects, including but not limited to NPV, C1 cash costs; all potential production from our copper projects; goals to maximize shareholder returns and maintain a strong balance sheet; goal of maintaining investment grade metrics; goal of balancing growth and capital returns; long-term zinc optionality; all economic and other projections for our copper growth projects, including but not limited to IRR, payback period, construction period, capex and mine life; impact of commodity price change on annualized EBITDA and annualized profit; liquidity and availability of borrowings under our credit facilities and the QB2 project finance facility; objectives and components of Teck’s capital allocation framework, including a base dividend and potential supplemental shareholder distribution and maintenance of solid investment grade metrics; sustainability goals; statement we are poised for growth; expectation that QB2 will be a long-life, low-cost operation with significant expansion potential, the impact of QB2 on Teck’s portfolio balance and QB; QB2 capital estimate and estimated COVID-19 impacts on costs at QB2; timing of first production at QB2; growth options and opportunities in copper, zinc and steelmaking coal; all guidance appearing in this document including but not limited to the production, sales, cost, unit cost, capital expenditure, cost reduction and other guidance; climate action goals and the expectation that we will achieve these goals; water management goals and expectation that we will achieve those goals; Elk Valley water treatment projections; benefits and impact of our RACE21™ program; long term annual steelmaking coal production of 26 to 27 million tonnes, and expectations of stable long term strip ratio; benefits of the Neptune facility upgrade; expectation of strong long-term cash flows in steelmaking coal; projected steelmaking coal sustaining capital; expected benefits of the haul truck rebuild strategy, including but not limited to the anticipated capex reduction, NPV and payback period; expectation that Teck’s coal is optimally positioned for a decarbonizing future; long-term sustaining capital expenditure projection in copper; long-term sustaining capital expenditure projection in zinc; expectations for Red Dog extension; Fort Hills debottlenecking potential; expectation of sufficient pipeline capacity for our energy business; the benefits of our innovation strategy and initiatives described under the “Technology and Innovation” Appendix and elsewhere; mine lives and duration of operations at our various mines and operations; expectations and forecasts for our products, business units and individual operations and projects; and forecasts for supply and demand for copper, zinc, steelmaking coal and oil.

The forward-looking statements are based on and involve numerous assumptions, risks and uncertainties and actual results may vary materially. These statements are based on assumptions, including, but not limited to, general business and economic conditions, interest rates, the supply and demand for, deliveries of, and the level and volatility of prices of, zinc, copper, coal, blended bitumen, and other primary metals, minerals and products as well as steel, oil, natural gas, petroleum, and related products, the timing of the receipt of regulatory and governmental approvals for our development projects and other operations and new technologies, our costs of production and production and productivity levels, as well as those of our competitors, power prices, continuing availability of water and power resources for our operations, market competition, the accuracy of our reserve estimates (including with respect to size, grade and recoverability) and the geological, operational and price assumptions on which these are based, conditions in financial markets, the future financial performance of the company, our ability to successfully implement our technology and innovation strategy, the performance of new technologies in accordance with our expectations, our ability to attract and retain skilled staff, our ability to procure equipment and operating supplies, positive results from the studies on our expansion projects, our coal and other product inventories, our ability to secure adequate transportation for our products, our ability to obtain permits for our operations and expansions, our ongoing relations with our employees and business partners and joint venturers, our expectations with respect to the carbon intensity of our operations, assumptions regarding returns of cash to shareholders include assumptions regarding our future business and prospects, other uses for cash or retaining cash. Our sustainability goals are based on a number of additional assumptions, including regarding the availability and effectiveness of technologies needed to achieve our sustainability goals and priorities; the availability of clean energy sources and zero-emissions alternatives for transportation on reasonable terms; our ability to implement new source control or mine design strategies and transition to seawater or low-quality water on commercially reasonable terms without impacting production objectives; our ability to successfully implement our technology and innovation strategy; and the performance of new technologies in accordance with our expectations. In addition, assumptions regarding the Elk Valley Water Quality Plan include assumptions that additional treatment will be effective at scale, and that the technology and facilities operate as expected. Reserve and resource life estimates assume the mine life of longest lived resource in the relevant commodity is achieved, assumes production at planned rates and in some cases development of as yet undeveloped projects. Assumptions regarding the benefits of the Neptune Bulk Terminals expansion and other projects include assumptions that the project is constructed and operated in accordance with current expectations. Capital allocation decisions, and decisions regarding the payment of dividends, are in the discretion of the board of directors. Assumptions regarding QB2 include assumption of completion based on current project assumptions and assumptions regarding the final feasibility study; assumptions regarding QB3 include assumptions regarding the receipt of permits. Assumptions regarding QB2 include current project assumptions and assumptions regarding the final feasibility study, CLP/USD exchange rate of 775, as well as there being no unexpected material and negative impact to the various contractors, suppliers and subcontractors for the QB2 project relating to COVID-19 or otherwise that would impair their ability to provide goods and services as anticipated during the suspension period or ramp-up of construction activities. Assumptions regarding the benefits of the Neptune Bulk Terminals expansion include assumptions that the project is constructed and operated in

Caution Regarding Forward-Looking Statements

accordance with current expectations, and upstream infrastructure is in place to support the additional capacity. Statements regarding the availability of our credit facilities and project financing facility are based on assumptions that we will be able to satisfy the conditions for borrowing at the time of a borrowing request and that the facilities are not otherwise terminated or accelerated due to an event of default. Statements concerning future production costs or volumes are based on numerous assumptions of management regarding operating matters and on assumptions that demand for products develops as anticipated, that customers and other counterparties perform their contractual obligations, that operating and capital plans will not be disrupted by issues such as mechanical failure, unavailability of parts and supplies, labour disturbances, interruption in transportation or utilities, adverse weather conditions, and that there are no material unanticipated variations in the cost of energy or supplies. Statements regarding anticipated steelmaking coal sales volumes and average steelmaking coal prices depend on, among other things, timely arrival of vessels and performance of our steelmaking coal-loading facilities, as well as the level of spot pricing sales. The foregoing list of assumptions is not exhaustive. Events or circumstances could cause actual results to vary materially. Assumptions are also included in the footnotes to the slides.

Factors that may cause actual results to vary materially include, but are not limited to: extended COVID-19 related suspension of activities and negative impacts on our suppliers, contractors, employees and customers; extended delays in return to normal operations due to COVID-19 related challenges; changes in commodity and power prices, changes in market demand for our products; changes in interest and currency exchange rates; acts of governments and the outcome of legal proceedings; inaccurate geological and metallurgical assumptions (including with respect to the size, grade and recoverability of mineral reserves and resources); unanticipated operational difficulties (including failure of plant, equipment or processes to operate in accordance with specifications or expectations, cost escalation, unavailability of materials and equipment, government action or delays in the receipt of government approvals, industrial disturbances or other job action, adverse weather conditions and unanticipated events related to health, safety and environmental matters); union labour disputes; political risk; social unrest; failure of customers or counterparties (including logistics suppliers) to perform their contractual obligations; changes in our credit ratings; unanticipated increases in costs to construct our development projects, difficulty in obtaining or retaining permits; inability to address concerns regarding permits or environmental impact assessments; current and new technologies relating to our Elk Valley water treatment efforts and other sustainability goals and targets may not perform as anticipated or may not be available, and ongoing monitoring may reveal unexpected environmental conditions requiring additional remedial measures; and changes or further deterioration in general economic conditions. Development of future reserves and resources is dependent on, among other factors, receipt of permits. Current and new technologies relating to our Elk Valley water treatment efforts may not perform as anticipated, and ongoing monitoring may reveal unexpected environmental conditions requiring additional remedial measures. QB2 costs, construction progress and timing of first production is dependent on, among other matters, our continued ability to successfully manage through the impacts of COVID-19. QB2 costs may also be affected by claims and other proceedings that might be brought against us relating to costs and impacts of the COVID-19 pandemic. Red Dog production may also be impacted by water levels at site.

The forward-looking statements in this presentation and actual results will also be impacted by the effects of COVID-19 and related matters. The overall effects of COVID-19 related matters on our business and operations and projects will depend on how the ability of our sites to maintain normal operations, and on the duration of impacts on our suppliers, customers and markets for our products, all of which are unknown at this time. Continuing operating activities is highly dependent on the progression of the pandemic and the success of measures taken to prevent transmission, which will influence when health and government authorities remove various restrictions on business activities.

We assume no obligation to update forward-looking statements except as required under securities laws. Further information concerning risks and uncertainties associated with these forward-looking statements and our business can be found in our Annual Information Form for the year ended December 31, 2020, filed under our profile on SEDAR (www.sedar.com) and on EDGAR (www.sec.gov) under cover of Form 40-F, as well as subsequent filings, including but not limited to our quarterly reports.

QB2 Project Disclosure

All economic analysis with respect to the QB2 project based on a development case which includes inferred resources within the life of mine plan, referred to as the Sanction Case, which is the case on which Teck based its development decision for the QB2 project. Inferred resources are considered too speculative geologically to have the economic considerations applied to them that would enable them to be categorized as mineral reserves. Inferred resources are subject to greater uncertainty than measured or indicated resources and it cannot be assumed that they will be successfully upgraded to measured and indicated through further drilling. Nonetheless, based on the nature of the mineralization, Teck has used a mine plan including inferred resources as the development mine plan for the QB2 project.

The economic analysis of the Sanction Case, which includes inferred resources, may be compared to economic analysis regarding a hypothetical mine plan which does not include the use of inferred resources as mill feed, referred to as the Reserve Case, and which is set out in Appendix slides "QB2 Project Economics Comparison" and "QB2 Reserves and Resources Comparison".

The scientific and technical information regarding the QB2 project and Teck's other material properties was prepared under the supervision of Rodrigo Marinho, P. Geo, who is an employee of Teck. Mr. Marinho is a qualified person, as defined under National Instrument 43-101.

Teck is Poised for Growth

Providing essential metals and minerals for a low-carbon world

- **Right Opportunities**
 - Strong demand for our metals and minerals, led by growth and decarbonization
- **Right Assets**
 - Industry leading copper growth, strengthening existing high-quality, low carbon assets
- **Right Approach**
 - Highest standards of safety, sustainability and operational excellence in everything we do, RACE21™
- **Right Team**
 - Our people deliver the optimal mix of industry leading technical, digital, sustainability, commercial and financial leadership



Health & Safety and Sustainability



Health & Safety

A core value for Teck

80% reduction in HPIF from 2016 to June 2021

38% lower HPIF YTD
26% lower LTIF YTD



Inclusion & Diversity

Enhancing representation and diversity

28% women in senior management

One-third of all new hires are women



Climate

Rebalancing to low-carbon metals

Carbon neutral operations by 2050

33% reduction in carbon intensity by 2030

88% green power at operations today



Communities

Serving the needs of communities and Indigenous Peoples

72 active agreements with Indigenous Peoples

24% of procurement spend with local suppliers



Water

Protecting water quality and reducing use

Tripling water treatment capacity in Elk Valley in 2021

Achieved **13% reduction** in freshwater use at Chilean operations; desalinated water at QB2

Accelerated Need for Essential Metals And Minerals for a Low-Carbon World

Copper Demand¹ (kt)

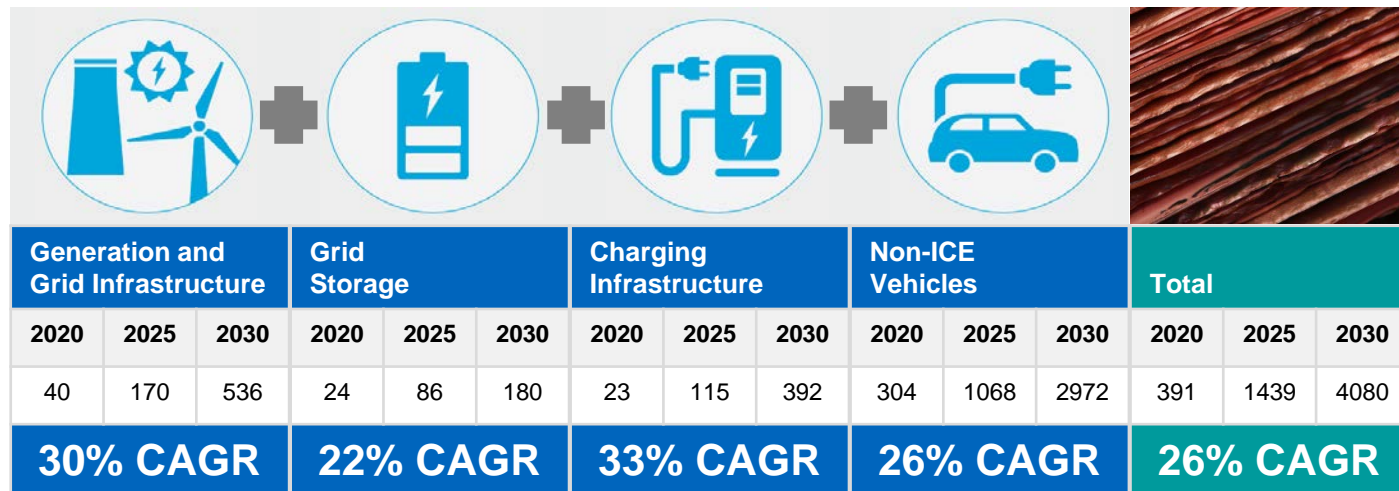

- Strong demand for metals and minerals driven by decarbonization, population growth and a rising middle class
- Unprecedented pandemic monetary and fiscal stimulus
- Economic recovery continues as vaccines are rolled out
- Current stockpiles of essential minerals remain at low levels

Teck is positioned to double copper production by 2023²

High-Quality Steelmaking Coal Is Required for the Low-Carbon Transition

Seaborne Steelmaking Coal Supply Changes With All Projects Through 2050¹ (Mt)

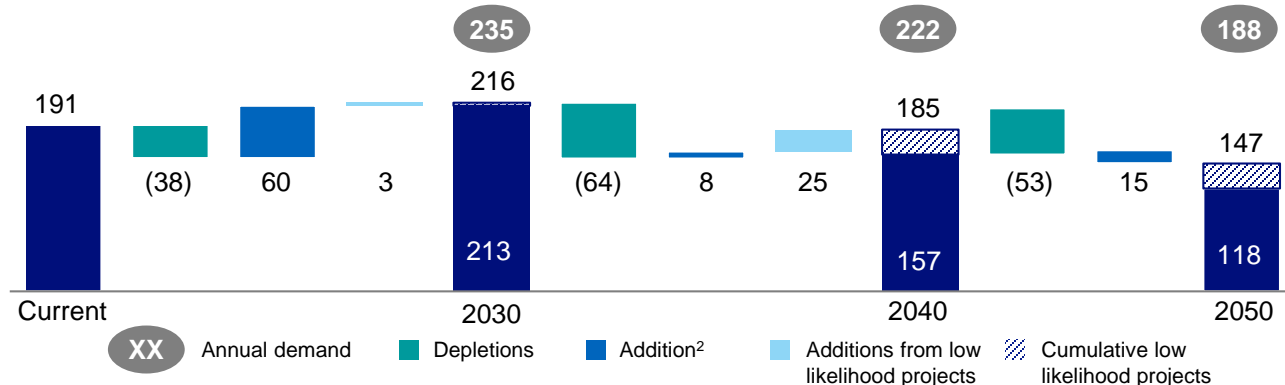

Seaborne Steelmaking Coal Supply/Demand Gap (Mt)

(Mt)	Net Capacity 2030	Net Capacity 2040	Net Capacity 2050
Gap with high likelihood projects	-22	-65	-70
Gap with high and low likelihood projects	-19	-37	-41

- The magnitude of steelmaking coal demand will be ultimately driven by the pace of decarbonization
- Long-term demand for seaborne steelmaking coal will remain robust
- At the same time, supply growth is constrained

Without the addition of confirmed and unconfirmed greenfield and brownfield projects, there will be a significant gap to steelmaking coal demand between 2025 and 2030

Teck and the Low-Carbon Transition

We believe Teck's strategy will ensure we are well-positioned for changes in demand for mining commodities driven by the transition to a low-carbon world

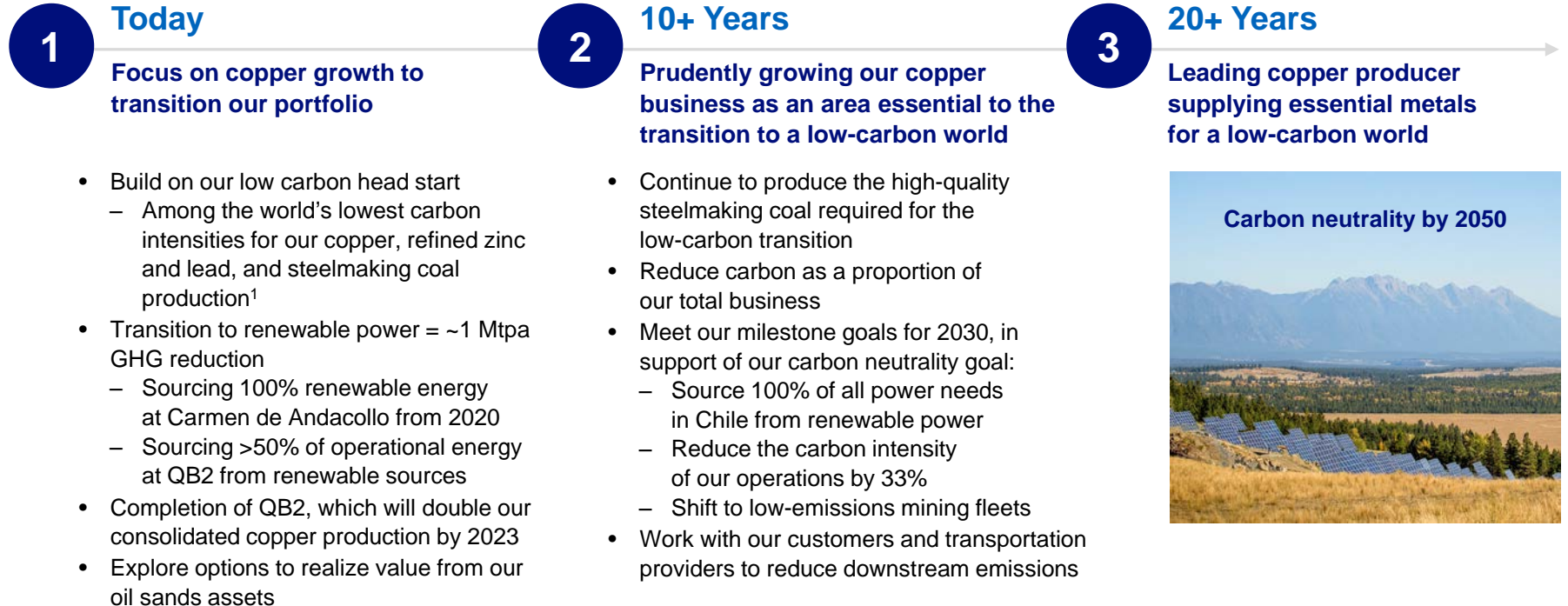

Prudent Copper Growth Strategy

Accelerate

capital efficient growth in copper

Maximize

cash flows from operations
to fund copper growth and shareholder returns

Strengthen

existing high-quality assets through RACE21™

Discipline

in capital allocation, maximizing shareholder returns

Leadership

in sustainability



Industry Leading Copper Growth

Teck has continued to invest in growth projects; peers have not

**WoodMac: Consolidated Copper Production Growth¹
Teck² vs. Peers³ 2021E-2023E**

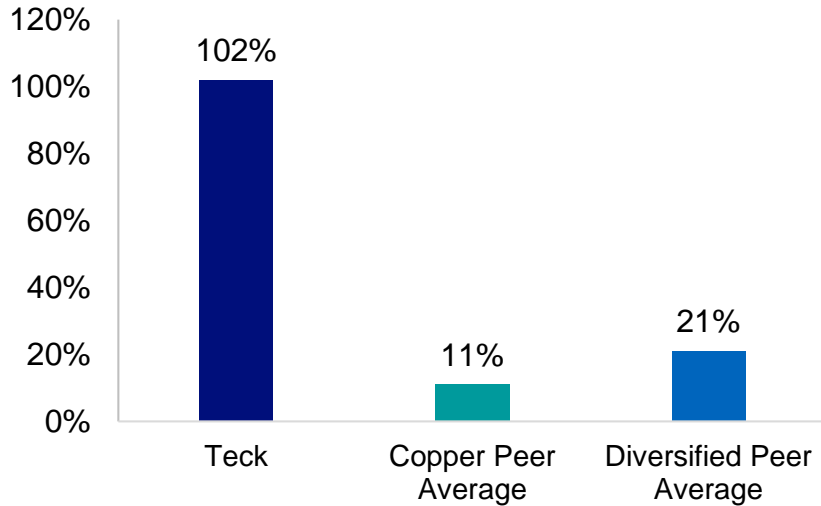

Teck provides investors exposure to industry leading copper growth and valuation unlock

QB2 Update

Successfully delivering on key milestones

Reached 60% Completion in Early August

- Vaccinations, COVID-19 protocols and testing key enablers
- First production expected in H2 2022
- Unchanged capital estimate before COVID-19 impacts (US\$5.2 billion¹)
- COVID-19 capital cost estimate (US\$600 million²)

Delivering to Key Milestones

- Workforce ramped up to maximize the use of camp space
- Critical path through the grinding circuit remains on plan
- Focus on port to pond infrastructure for first water delivery
- Focused support in specific areas to deliver to plan
- Initiatives and incentive programs driving behaviour
- Working creatively with Bechtel and contractors for successful delivery

Coarse Ore Stockpile Area

Dome foundation, stacker structure and reclaim tunnels



World class COVID-19 protocols deliver results

Portfolio of Copper Growth Options

Well understood resource base creates multiple options

- High quality resources in very attractive mineral districts including Canada, the U.S., Mexico, Chile, and Peru
 - Including ~22 million ounces¹ of measured and indicated gold resources, and ~10 million ounces¹ in inferred gold resources in our copper growth options¹
- Prudent investment to further define path to value, e.g. conversion of resources to reserves
- Leveraging exploration, development and commercial expertise
- Sustainability and community focus

Teck's Consolidated Copper Asset Reserves and Resources (CuEq Mt)²

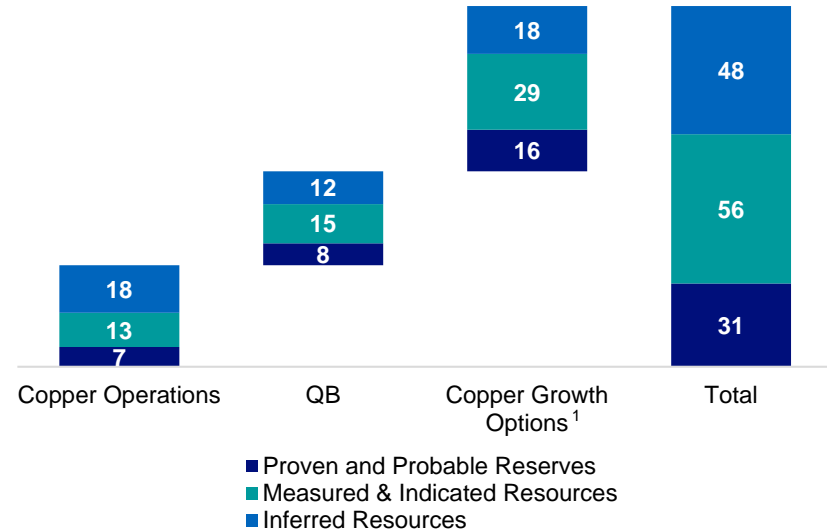

Continued investment has resulted in a robust pipeline of copper growth options

Significant Base Metals Growth

Teck's Base Metals business rivals leading copper peers

Consolidated Copper Equivalent Production ¹ (kt CuEq)

■ Copper ■ Zinc (CuEq) ■ Other (CuEq) ■ Attributable (CuEq)

Teck

First Quantum

Antofagasta

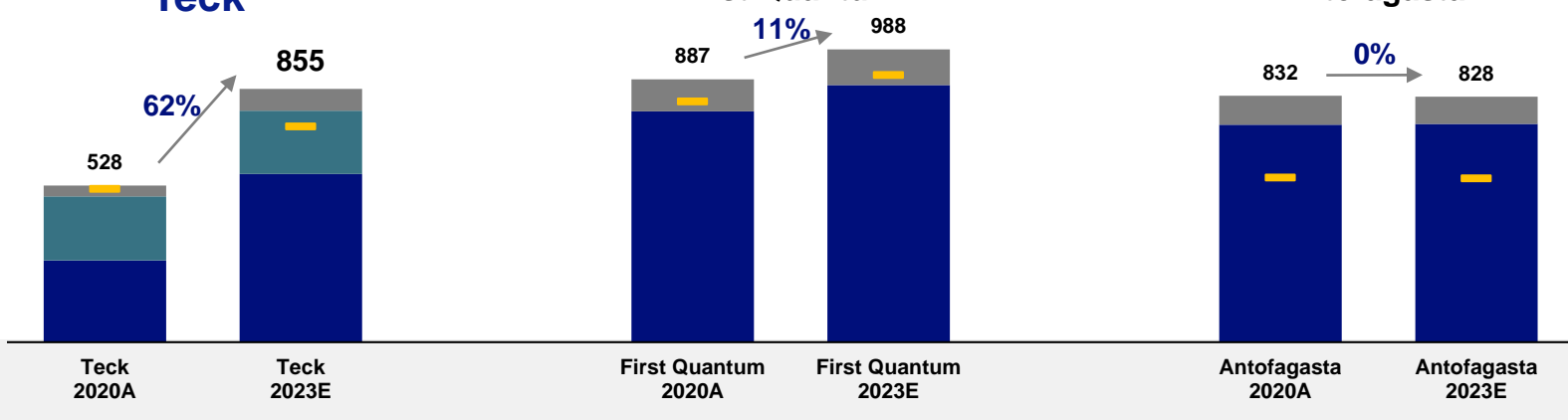

C1 Cost²
(US\$/lb Cu)

\$1.28

\$1.16

\$1.21

\$1.33

\$1.14

\$1.14

Enterprise
Value³ (C\$B)

\$29.9

\$27.3

Teck Illustrative Cash Flows - QB2 Full Production

Scenarios indicate potential Available Cash Flow of C\$4–6/share

US\$4.50/lb Copper Scenario

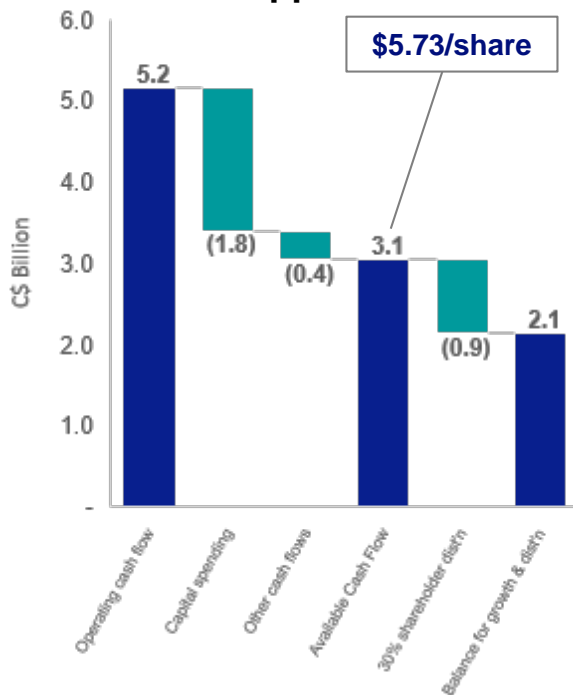

US\$4.00/lb Copper Scenario

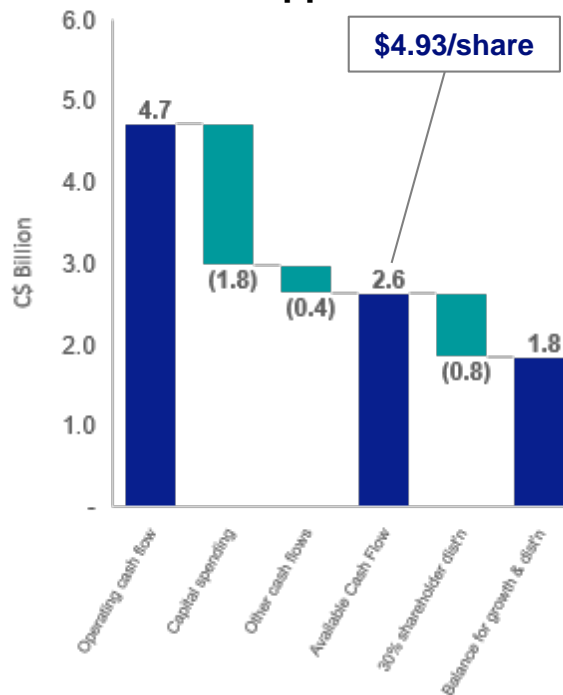

US\$3.50/lb Copper Scenario

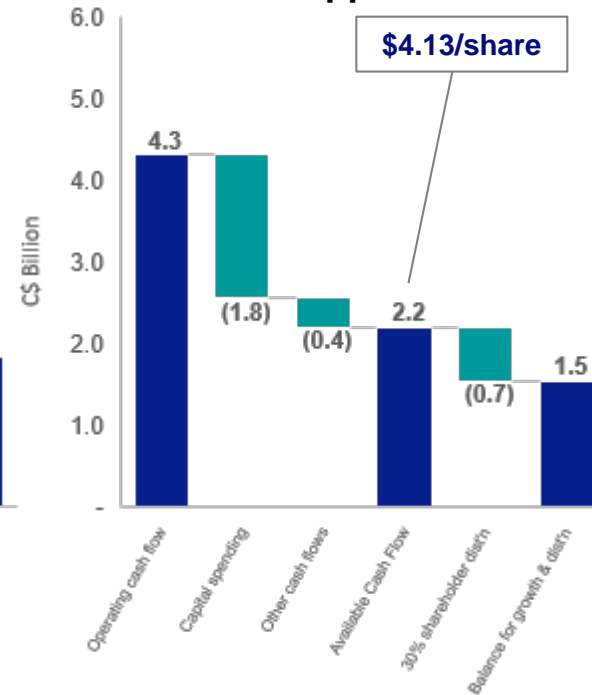

For further details please see Teck Illustrative Cash Flows – QB2 Full Production slides in the appendix of this presentation.

For this purpose, we define available cash flow as cash flow from operating activities after interest and finance charges, lease payments and distributions to non-controlling interests less: (i) sustaining capital and capitalized stripping; (ii) committed growth capital; (iii) any cash required to adjust the capital structure to maintain solid investment grade credit metrics; and (iv) our base \$0.20 per share annual dividend. Proceeds from any asset sales may also be used to supplement available cash flow. Any additional cash returns will be made through share repurchases and/or supplemental dividends depending on market conditions at the relevant time.

Solid Track Record of Cash Returns to Shareholders

>C\$3.0 billion of dividends and C\$1.7 billion of share buybacks 2011-2020

Teck's Dividends and Buybacks (C\$M)

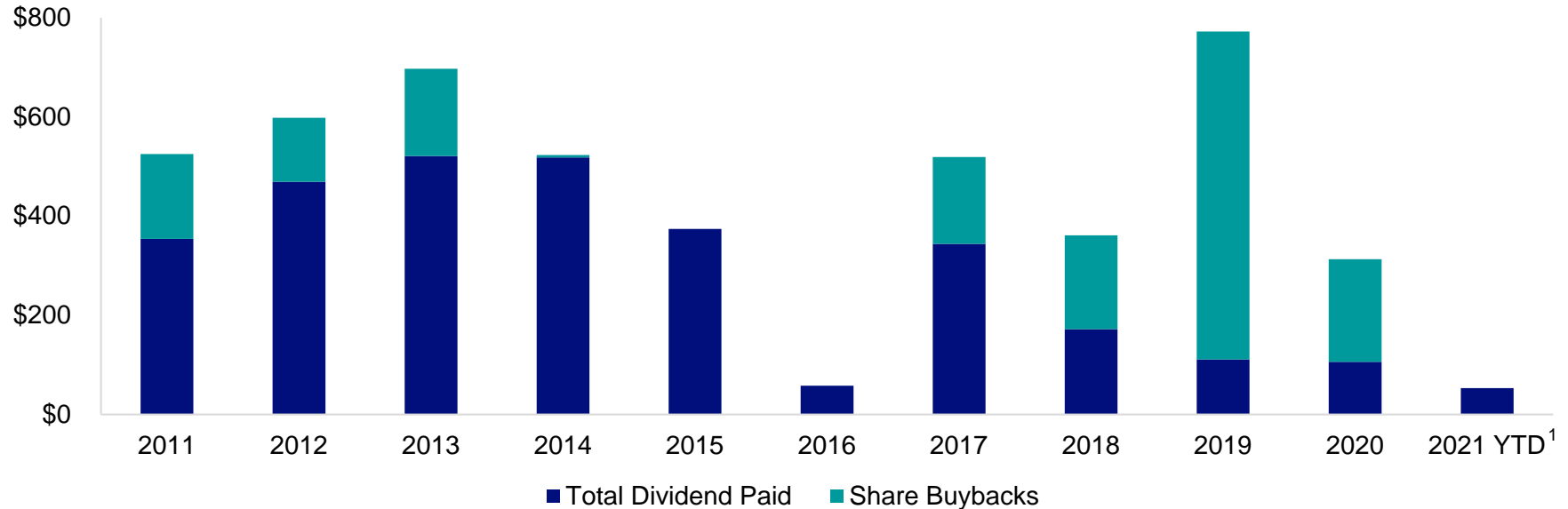

>C\$4.7 billion of dividends and share buybacks over the past ten years

Teck is Poised for Growth



Right Opportunities

Strong demand for our metals and minerals, led by growth and decarbonization



Right Assets

Industry leading copper growth, strengthening existing high-quality, low carbon assets



Right Approach

Highest standards of sustainability in everything we do, operational excellence, RACE21™



Right Team

Our people deliver the optimal mix of industry leading technical, digital, sustainability, commercial and financial leadership

Providing essential metals and minerals for a low-carbon world

Appendix

Endnotes:

Slide 6: Accelerated Need for Essential Metals and Minerals for a Low-Carbon World

1. Source: CRU Mobility and Energy Futures – Perspectives towards 2035. Approximate figures; total copper demand from CRU's Copper Market Outlook.
2. Consolidated basis.

Slide 7: High-Quality Steelmaking Coal Is Required for the Low-Carbon Transition

1. Source: MineSpans. All production volumes included in the forecast are based on a 93% utilization rate of capacity. Includes ramp up of current capacity and projects considered to have a high certainty or probability of completion.
2. Low likelihood projects are assumed to come online based on increasing prices surpassing the incentive price required for individual projects at a return on investment of 15%.

Slide 8: Teck and the Low-Carbon Transition

1. Barclays Research; Teck. 2017.

Slide 10: Industry Leading Copper Growth

1. Source: Wood Mackenzie base case (attributable) copper production dataset. Consolidated production estimates were derived based on accounting standards for consolidation for Teck and its peers.
2. Teck growth estimate uses 2020 actual production and Wood Mackenzie data for 2023.
3. Copper peers: Antofagasta, First Quantum, Freeport, Hudbay, Lundin, Southern Copper. Diversified peers: Anglo American, BHP, Glencore, Rio Tinto. Peer production metrics for 2020 and 2023 are from Wood Mackenzie. Peer production metrics for 2020 and 2023 are from Wood Mackenzie. Peer averages are the simple averages.

Slide 12: Portfolio of Copper Growth Options

1. Contained equivalent copper metal at 100% basis for all projects. Copper growth assets are: Zafranal, San Nicolás, NuevaUnión, Mesaba, Schaft Creek, Galore Creek. See Teck's 2020 AIF for further information, including the grade and quantity, regarding the gold reserves and resources for these projects and the grade of the other metals used to determine the copper equivalent.
2. Contained equivalent copper metal at 100% basis for all projects. CuEq calculated with price assumptions: US\$3.50/lb Cu; US\$1.15/lb Zn; US\$6.90/lb Ni; US\$21/lb Co; US\$10/lb Mo; US\$1,400/oz Au; US\$18/oz Ag; US\$1,300/oz Pt; US\$1,200/oz Pt.

Slide 11: QB2 Update - Successfully delivering on key milestones

1. On a 100% go forward basis from January 1, 2019 including escalation and excluding working capital or interest during construction using actual realized exchange rates until March 30, 2020 and assuming a CLP/USD exchange rate of 775 from April 1, 2020. Includes approximately US\$400 million in contingency.
2. Based on the assumptions and impacts to construction productivity under COVID-19 protocols. Assumes a CLP/USD rate of 775 over the remainder of the project.

Slide 13: Significant Base Metals Growth - Teck's Base Metals business rivals leading copper peers

1. Production for 2020 reflects actuals sourced from company disclosures. Production for 2023 is sourced from Wood Mackenzie asset models, considering assets included in Wood Mackenzie's base case for each company. Production is shown on a consolidated reporting basis, except where noted as attributable for ownership. Copper equivalent production for 2020 is calculated using annual average prices of: US\$2.83/lb Cu, US\$1.05/lb Zn, US\$0.85/lb Pb, US\$8.68/lb Mo, US\$1,779/oz Au, US\$20.70/oz Ag, US\$6.43/lb Ni. Copper equivalent production for 2023 is calculated using the following prices: US\$3.50/lb Cu, US\$1.15/lb Zn, US\$0.90/lb Pb, US\$10.50/lb Mo, US\$1,650/oz Au, US\$22.50/oz Ag, US\$6.90/lb Ni.
2. 2020 C1 cash cost data is sourced from company disclosures and are for copper operations only. Expected 2023 C1 cash cost data is sourced from S&P Global Market Intelligence (formerly SNL Metals & Mining) cost curve database considering primary copper mines and total cash costs on a by-product basis for Teck and peers, and weighted on a consolidated production basis.
3. Enterprise Value, or Total Enterprise Value is as of market close on August 30, 2021 and is sourced from S&P Capital IQ.

Slide 15: Solid Track Record of Cash Returns to Shareholders

1. As at June 30, 2021.

Overview and Financial Strategy

Teck



About Teck



High-quality assets in the Americas



Proven operational excellence underpinning cost competitiveness



Doubling of copper production by 2023 through QB2¹
Significant value potential from a portfolio of copper growth options



Recognized industry leader in ESG performance



Strong balance sheet and rigorous capital allocation framework

One of Canada's leading mining companies, headquartered in Vancouver, British Columbia

Among the world's lowest carbon intensity producers of copper, zinc and steelmaking coal

Strong safety performance with stringent COVID-19 prevention protocols in place across the business

Experienced leadership team with proven track record of project execution and operational excellence

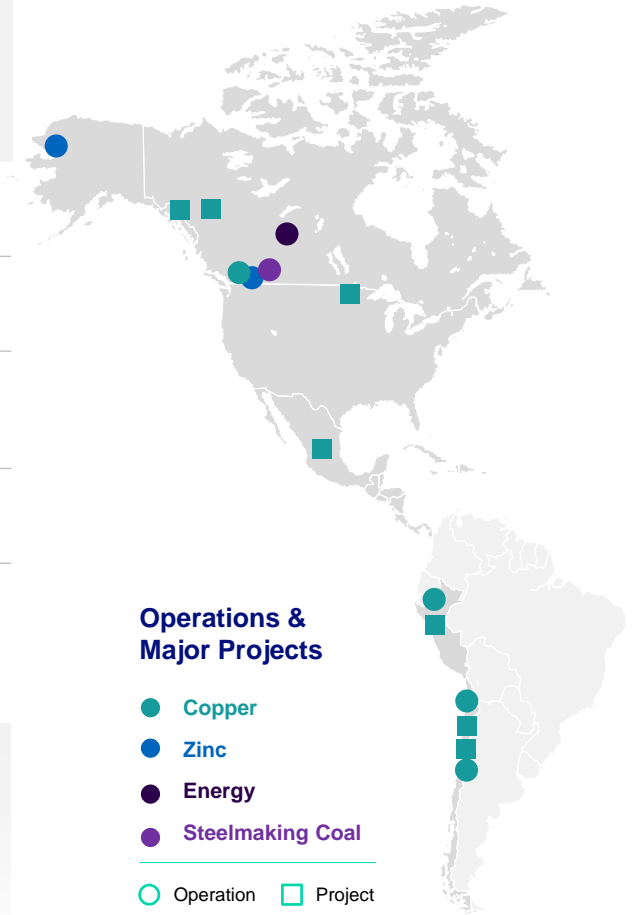

Global Customer Base

Revenue contribution from diverse markets

2020 Revenue by Business Unit

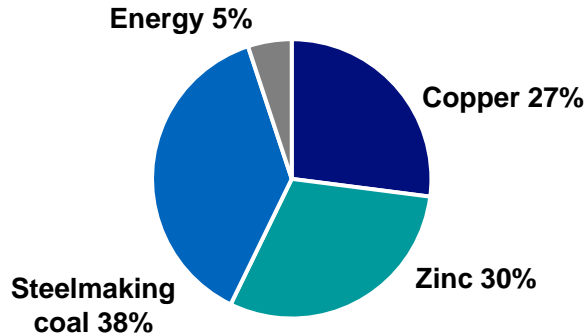

2020 Gross Profit Before Depreciation and Amortization¹ by Business Unit

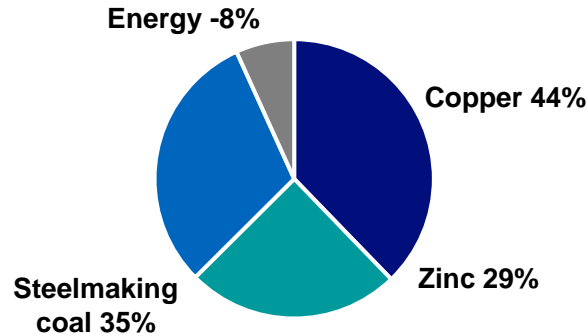

2020 Revenue by Geography

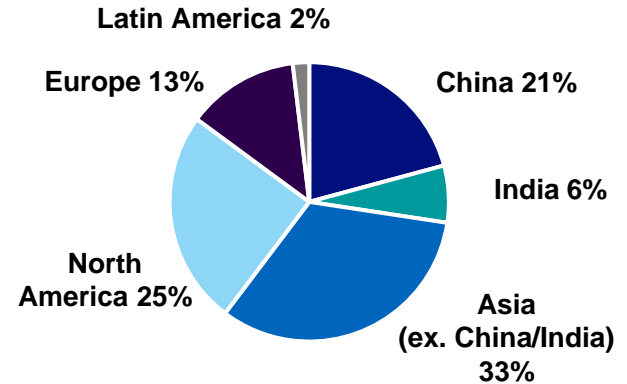

Strong Financial Position

Investment grade credit rating, with substantial liquidity

Balance Sheet

- Rated investment grade by all four agencies

Liquidity

- C\$6.3 billion of liquidity available¹
- US\$5.0 billion of committed revolving credit facilities
- No earnings or cash-flow based financial covenant, no credit rating trigger, no general material adverse effect borrowing condition

Significant leverage to rising commodity prices

	Production ⁴	Change	Estimated Effect on Annualized Profit ⁵	Estimated Effect on Annualized EBITDA ⁵
Copper ³	282.5 kt	US\$0.50/lb	C\$200M	C\$350M
Zinc ^{3,6}	912.5 kt	US\$0.10/lb	C\$90M	C\$120M
Coal ⁷	26.0 Mt	US\$50/t	C\$950M	C\$1,500M

Long dated maturity profile with no significant note maturities prior to 2030² (C\$M)

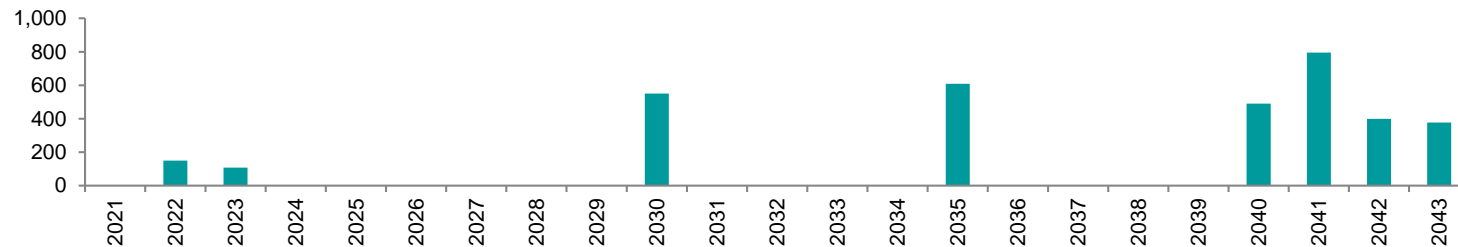

Teck Illustrative Cash Flows - QB2 Full Production

Scenarios indicate potential Available Cash Flow of C\$4–6/share

Illustrative Available Cash Flow (C\$B)

	US\$4.50/lb Copper	C\$/share ⁹	US\$4.00/lb Copper	C\$/share ⁹	US\$3.50/lb Copper	C\$/share ⁹
Adjusted EBITDA ¹	\$6.0		\$5.6		\$5.3	
QB2 EBITDA (100%) ²	2.6		2.2		1.8	
Less: cash taxes (100%) ³	(1.9)		(1.7)		(1.5)	
Less: cash interest paid ⁴	(0.4)		(0.4)		(0.4)	
Less: lease payments ⁵	(0.1)		(0.1)		(0.1)	
Operating cash flow	\$6.2		\$5.6		\$5.0	
Less: capital spending ⁶	(1.8)		(1.8)		(1.8)	
Less: base dividends ⁷	(0.1)		(0.1)		(0.1)	
Less: QB2 project finance repayment (100%) ⁸	(0.4)		(0.4)		(0.4)	
Illustrative Available Cash Flow (100%)	\$3.9		\$3.4		\$2.8	
Illustrative Available Cash Flow (Teck's share)	3.1	\$5.73	2.6	\$4.93	2.2	\$4.13
30% of Teck's Available Cash Flow for supplemental distribution	(0.9)	(1.72)	(0.8)	(1.48)	(0.7)	(1.24)
Balance available for Teck's growth and shareholders	\$2.1	\$4.01	\$ 1.8	\$3.45	\$1.5	\$2.89
Gross Debt/EBITDA (Teck's share; assumes June 30, 2021 reported gross debt)	0.96x		1.04x		1.13x	

Illustrative Proforma; includes QB2 on a 100% consolidation basis; QB2 EBITDA assumes 290ktpy copper sales and US\$1.28/lb C1 cash cost.

For this purpose, we define available cash flow as cash flow from operating activities after interest and finance charges, lease payments and distributions to non-controlling interests less: (i) sustaining capital and capitalized stripping; (ii) committed growth capital; (iii) any cash required to adjust the capital structure to maintain solid investment grade credit metrics; and (iv) our base \$0.20 per share annual dividend. Proceeds from any asset sales may also be used to supplement available cash flow. Any additional cash returns will be made through share repurchases and/or supplemental dividends depending on market conditions at the relevant time.

Teck's Capital Allocation Framework

Shareholder distributions of 30-100% of Available Cash Flow¹

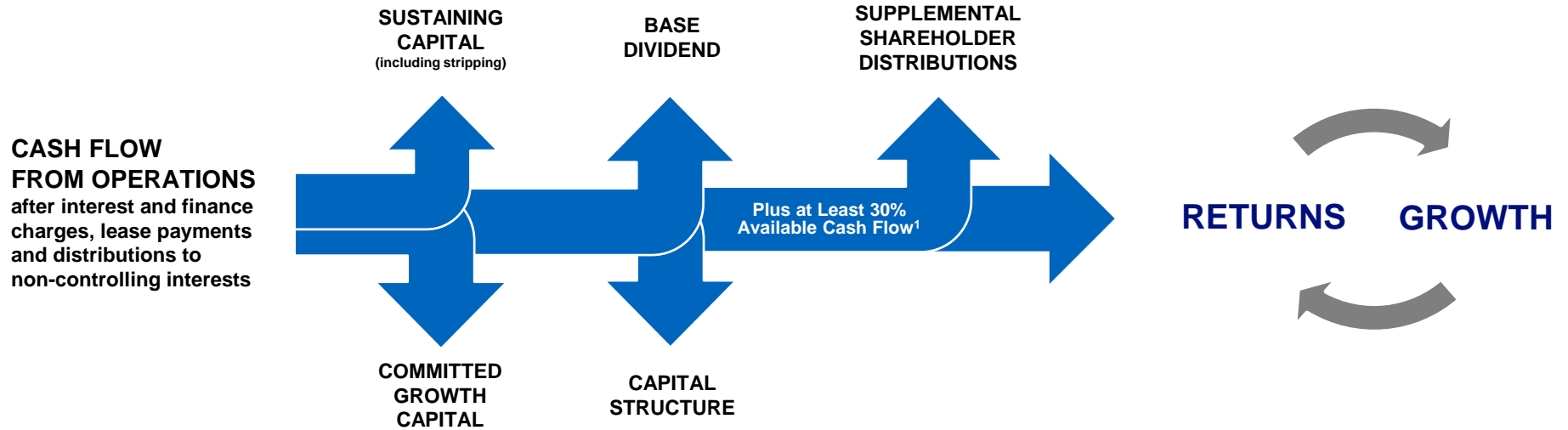

Teck targets through-cycle BBB metrics (Net Debt to Adjusted EBITDA²)

1. For this purpose, we define available cash flow as cash flow from operating activities after interest and finance charges, lease payments and distributions to non-controlling interests less: (i) sustaining capital and capitalized stripping; (ii) committed growth capital; (iii) any cash required to adjust the capital structure to maintain solid investment grade credit metrics; and (iv) our base \$0.20 per share annual dividend. Proceeds from any asset sales may also be used to supplement available cash flow. Any additional cash returns will be made through share repurchases and/or supplemental dividends depending on market conditions at the relevant time.
2. Net Debt to Adjusted EBITDA ratio is a non-GAAP financial measure. See "Non-GAAP Financial Measures" slides.

Disciplined Approach to M&A

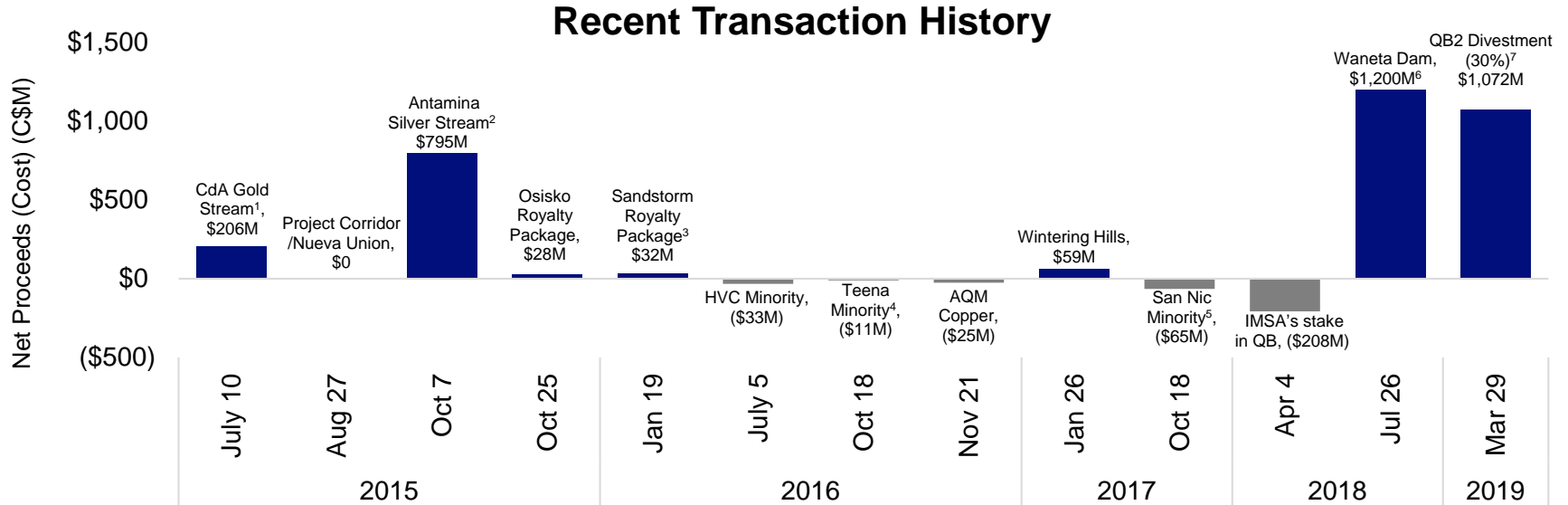

Total net proceeds of C\$3.1B:

- Balance sheet strengthened by divestment of non-core assets at high EBITDA⁸ multiples
- Modest 'prudent housekeeping' acquisitions to consolidate control of attractive copper and zinc development assets

Production Guidance

Units in 000's tonnes (excluding steelmaking coal, molybdenum, and bitumen)	2020	2021 Guidance ¹	3-Year Guidance ¹ (2022-2024)
Copper^{2,3,4}			
Highland Valley	119.3	128-133	135-165
Antamina	85.6	91-95	90
Carmen de Andecollo	57.4	46-51	50-60
Quebrada Blanca ⁶	13.4	10-11	-
Total copper	275.7	275-290	275-315
Zinc^{2,3,5}			
Red Dog	490.7	510-530	510-550
Antamina	96.3	95-100	80-100
Total zinc	587.0	603-630	590-650
Refined zinc			
Trail	305.1	285-290	305-315
Steelmaking coal (Mt)	21.1	25.0-26.0	26.0-27.0
Bitumen³ (Mbbbl)			
Fort Hills	8.4	6.6-8.1	14
Lead²			
Red Dog	97.5	90-100	80-90
Molybdenum^{2,3} (Mlbs)			
Highland Valley	3.8	1.2-1.8	3.0-4.5
Antamina	1.5	1.0-1.4	2.0-3.0
Total molybdenum	5.1	2.2-3.2	5.0-7.5

Sales and Unit Cost Guidance

Sales	Q2 2021	Q3 2021 Guidance ¹
Zinc²		
Red Dog (kt)	39	145-155
Steelmaking coal (Mt)	6.2	6.0-6.4
Unit Costs	2020	2021 Guidance ¹
Copper³		
Total cash unit costs ⁷ (US\$/lb)	\$1.57	\$1.65-1.75
Net cash unit costs ^{4,7} (US\$/lb)	\$1.28	\$1.30-1.40
Zinc⁵		
Total cash unit costs ⁷ (US\$/lb)	\$0.53	\$0.54-0.59
Net cash unit costs ^{4,7} (US\$/lb)	\$0.36	\$0.35-0.40
Steelmaking coal⁶		
Adjusted site cash cost of sales ⁷	\$64	\$59-64
Transportation costs	\$41	\$39-42
Inventory write-down	\$3	-
Unit costs ⁷ (C\$/tonne)	\$108	\$98-108
Bitumen		
Adjusted operating costs ⁷ (C\$/barrel)	C\$31.96	C\$40-44

Water Treatment Guidance

Excerpt from Teck's Q2 2021 Press Release

There is no change to our 2021 guidance on water-related spending. We expect capital spending of approximately \$255 million in 2021 on water treatment (AWTFs and SRFs) and water management (source control, calcite management and tributary management). By the end of 2021, we expect to increase total treatment capacity to more than 50 million litres per day. From 2022 to 2024, capital investment in water management and water treatment is expected to increase by approximately \$100 million to \$400 to \$500 million as we are advancing the timing of water treatment from future years to support continued mine development. The investment in water treatment will further increase treatment capacity to 90 million litres per day.

In addition to the capital set out above and as previously announced, the aggregate cost of the incremental measures required under the October 2020 Direction issued by Environment and Climate Change Canada (the Direction) is preliminarily estimated at \$350 to \$400 million between 2021 and 2030.

Operating costs associated with water treatment were approximately \$0.75 per tonne in 2020 and, as previously disclosed, are projected to increase gradually over the long term to approximately \$3 per tonne as additional water treatment becomes operational. Long-term capital costs for construction of additional treatment facilities are expected to average approximately \$2 per tonne annually.

Final costs of implementing the Plan and the Direction for managing water quality will depend in part on the technologies applied, on regulatory developments and on the results of ongoing environmental monitoring and modelling. The timing of expenditures will depend on resolution of technical issues, permitting timelines and other factors. Certain cost estimates are based on limited engineering and the feasibility of certain measures has not yet been confirmed. Implementation of the Plan also requires additional operating permits. We expect that, in order to maintain water quality, some form of water treatment will continue for an indefinite period after mining operations end. The Plan contemplates ongoing monitoring to ensure that the water quality targets set out in the Plan are in fact protective of the environment and human health, and provides for adjustments if warranted by monitoring results. This ongoing monitoring, as well as our continued research into treatment technologies, could reveal unexpected environmental impacts, technical issues or advances associated with potential treatment technologies that could substantially increase or decrease both capital and operating costs associated with water quality management, or that could materially affect our ability to permit mine life extensions in new mining areas.

Capital Expenditures Guidance

Sustaining and Growth Capital

(Teck's share in CAD\$ millions)	2020	2021 Guidance ¹
Sustaining		
Copper	\$ 161	\$ 160
Zinc	188	155
Steelmaking coal ²	571	430
Energy	91	85
Corporate	12	-
Total sustaining	\$ 1,023	\$ 830
Growth³		
Copper ⁴	\$ 41	\$ 125
Zinc	7	25
Steelmaking coal	411	460
Corporate	4	5
	\$ 463	\$ 615
Total		
Copper	\$ 202	\$ 285
Zinc	195	180
Steelmaking coal	982	890
Energy	91	85
Corporate	16	5
	\$ 1,486	\$ 1,445

QB2

(Teck's share in CAD\$ millions)	2020	2021 Guidance ¹
QB2 capital expenditures	\$ 1,643	\$ 2,500
Total before SMM/SC contributions	3,129	3,945
Estimated SMM/SC contributions	(660)	(440)
Estimated QB2 project financing draw to capex	(983)	(1,425)
Total, net of partner contributions and project financing	\$ 1,486	\$ 2,080

Capitalized Stripping

(Teck's share in CAD\$ millions)	2020	2021 Guidance ¹
Capitalized Stripping		
Copper	\$ 145	\$ 205
Zinc	51	70
Steelmaking coal	303	400
	\$ 499	\$ 675

Commodity Price Leverage¹

	2021 Mid-Range Production Estimates ^{2,5}	Change	Estimated Effect on Annualized Profit ³ (\$M)	Estimated Effect on Annualized EBITDA ³ (\$M)
US\$ exchange		C\$0.01	\$55	\$87
Copper (kt)	282.5	US\$0.01/lb	\$4	\$7
Zinc ⁴ (kt)	912.5	US\$0.01/lb	\$9	\$12
Steelmaking coal (Mt)	25.5	US\$1/tonne	\$18	\$29
WCS ⁵ (Mbbbl)	7.4	US\$1/bbl	\$6	\$8
WTI ⁶		US\$1/bbl	\$2	\$3

Tax-Efficient Earnings in Canada and Chile

Canada: ~C\$4.5 billion in available tax pools at December 31, 2020

- Includes:
 - \$3.8 billion in Canadian federal net operating loss carryforwards
 - \$0.3 billion in Canadian Development Expenses (30% declining balance p.a.)
 - \$0.4 billion in allowable capital loss carryforwards
- Applies to cash income taxes in Canada
- Does not apply to:
 - Resource taxes in Canada
 - Cash taxes in foreign jurisdictions

Chile: ~C\$800 million in available tax pools at December 31, 2020

- Chilean net operating loss carryforwards
- Applies to cash income taxes for QB2

Share Structure & Principal Shareholders

Teck Resources Limited at December 31, 2020

	Shares Held	Percent	Voting Rights
Class A Shareholdings			
Temagami Mining Company Limited	4,300,000	55.4%	
SMM Resources Inc (Sumitomo)	1,469,000	18.9%	
Other	<u>1,996,503</u>	<u>25.7%</u>	
	7,765,503	100.0%	
Class B Shareholdings			
Temagami Mining Company Limited	725,000	0.1%	
SMM Resources Inc (Sumitomo)	295,800	0.1%	
China Investment Corporation (Fullbloom)	59,304,474	11.3%	
Other	<u>463,056,146</u>	<u>88.5%</u>	
	523,381,420	100.0%	
Total Shareholdings			
Temagami Mining Company Limited	5,025,000	0.9%	33.1%
SMM Resources Inc (Sumitomo)	1,764,800	0.3%	11.3%
China Investment Corporation (Fullbloom)	59,304,474	11.2%	4.6%
Other	<u>465,052,649</u>	<u>87.6%</u>	<u>51.0%</u>
	531,146,923	100.0%	100.0%

Collective Agreements

Operation	Expiry Dates
Antamina	July 31, 2021
Highland Valley Copper	September 30, 2021
Trail Operations	May 31, 2022
Cardinal River	June 30, 2022
Quebrada Blanca	January 31, 2022
	March 31, 2022
	November 20, 2022
Carmen de Andacollo	September 30, 2022
	December 31, 2022
Line Creek	May 31, 2024
Elkview	October 31, 2026
Fording River	April 30, 2027

Endnotes: Overview and Financial Strategy

Slide 21: Global Customer Base

1. Gross profit before depreciation and amortization is a non-GAAP financial measure. See "Non-GAAP Financial Measures" slides.

Slide 22: Strong Financial Position

1. As at July 26, 2021.
2. Based on Teck's US\$3.5 billion of public notes outstanding as at June 30, 2021, excluding project finance debt, draws on the revolving credit facility, leases and debt at Antamina and Neptune Terminals.
3. As at July 26, 2021. The sensitivity of our EBITDA to changes in the Canadian/U.S. dollar exchange rate and commodity prices, before pricing adjustments, based on our current balance sheet, our 2021 mid-range production estimates, current commodity prices and a Canadian/U.S. dollar exchange rate of \$1.25. See Teck's Q2 2021 press release for further details.
4. All production estimates are subject to change based on market and operating conditions.
5. The effect on our EBITDA of commodity price movements will vary from quarter to quarter depending on sales volumes. Our estimate of the sensitivity of EBITDA to changes in the U.S. dollar exchange rate is sensitive to commodity price assumptions. See Caution Regarding Forward-Looking Statements for a further discussion of factors that may cause actual results to vary from our estimates. EBITDA is a non-GAAP financial measure. See "Non-GAAP Financial Measures" slides.
6. Zinc includes 295,000 tonnes of refined zinc and 617,500 tonnes of zinc contained in concentrate.
7. Sensitivities from Teck's 2020 Annual Report. The sensitivity of our annual profit attributable to shareholders and EBITDA to changes in the Canadian/U.S. dollar exchange rate and commodity prices, before pricing adjustments, based on a 26.0 million tonne production volume estimate, our current balance sheet, current commodity prices and a Canadian/U.S. dollar exchange rate of \$1.30. See Teck's Q4 2020 press release for further details.

Slide 23: Teck Illustrative Cash Flows – QB2 Full Production

1. Adjusted EBITDA is H1 2021 Adjusted EBITDA annualized and price adjusted assuming copper prices of US\$4.50, US\$4.00, and US\$3.50 per pound, and a hard coking coal (HCC) price of US\$199/t FOB Australia. All other commodity prices are at H1 2021 actual average prices of copper US\$4.13 per pound, zinc US\$1.29 per pound, steelmaking coal US\$137.50 per tonne realized price, Western Canadian Select (WCS) US\$49.78 per barrel, West Texas Intermediate (WTI) US\$62.16 per barrel and a Canadian/U.S. dollar exchange rate of \$1.25. The sensitivity of our EBITDA to changes in the Canadian/U.S. dollar exchange rate and commodity prices are: C\$0.01 change in US\$ FX = C\$87 million EBITDA; US\$ 0.01/lb change in copper price = C\$7 million EBITDA; US\$ 0.01/lb change in zinc price = C\$12 million EBITDA; US\$1/tonne change in steelmaking coal price = C\$29 million EBITDA; US\$1/bbl change in WCS price = C\$8 million EBITDA; US\$1/bbl change in WTI price = C\$3 million EBITDA. EBITDA and Adjusted EBITDA are non-GAAP financial measures. See "Non-GAAP Financial Measures" slides.
2. QB2 EBITDA assumes a C1 cash cost of US\$1.28/lb, a Canadian/U.S. dollar exchange rate of \$1.25, and annual copper sales of 290,000 tonnes. EBITDA is a non-GAAP financial measure. See "Non-GAAP Financial Measures" slides.
3. Annualized H1 2021 cash taxes adjusted for future Canadian cash taxability on the basis of spot HCC prices, and future QB2 taxability, post-QB2 ramp up and post QB2 accelerated tax depreciation period. QB2 cash taxes are calculated on a post-financing basis.
4. Annualized H1 2021 cash interest paid.
5. Lease payments are annualized H1 2021 lease payments (C\$130 million/year).
6. Q2 2021 guidance for capital expenditures.
7. Base dividend of C\$0.20/share, paid quarterly.
8. QB2 project finance repayments are two semi-annual principal repayments of US\$147 million each.
9. Per share amounts assume 532.4 million shares outstanding as at June 30, 2021.

Slide 25: Disciplined Approach to M&A

1. Carmen de Andacollo gold stream transaction occurred in USD at US\$162 million.
2. Antamina silver stream transaction occurred in USD at US\$610 million.
3. Sandstorm royalty transaction occurred in USD at US\$22 million.
4. Teena transaction occurred in AUD at A\$10.6 million.
5. San Nicolàs transaction occurred in USD at US\$50 million.
6. Waneta Dam transaction closed July 26, 2018 for C\$1.2 billion.
7. QB2 Partnership (sale of 30% interest of project to Sumitomo; SMM and SC) for total consideration of US\$1.2 billion, including US\$800 million earn-in and US\$400 million matching contribution; converted at FX of 1.34 on March 29, 2019.
8. EBITDA is a non-GAAP financial measure. See "Non-GAAP Financial Measures" slides.

Endnotes: Overview and Financial Strategy

Slide 26: Production Guidance

1. As at September 20, 2021. See Teck's Q2 2021 press release and Teck's press release "Teck Investor and Analyst Day and Guidance Update" dated September 20, 2021 for further details.
2. Metal contained in concentrate.
3. We include 100% of production and sales from our Quebrada Blanca and Carmen de Andacollo mines in our production and sales volumes, even though we do not own 100% of these operations, because we fully consolidate their results in our financial statements. We include 22.5% and 21.3% of production and sales from Antamina and Fort Hills, respectively, representing our proportionate ownership interest in these operations.
4. Copper production includes cathode production at Quebrada Blanca and Carmen de Andacollo.
5. Total zinc includes co-product zinc production from our 22.5% proportionate interest in Antamina.
6. Three-year guidance 2022-2024 excludes production from QB2.

Slide 27: Sales and Unit Cost Guidance

1. As at September 20, 2021. See Teck's Q2 2021 press release and Teck's press release "Teck Investor and Analyst Day and Guidance Update" dated September 20, 2021 for further details.
2. Metal contained in concentrate.
3. Copper unit costs are reported in U.S. dollars per payable pound of metal contained in concentrate. Copper net cash unit costs include adjusted cash cost of sales and smelter processing charges, less cash margins for by-products including co-products. Guidance for 2021 assumes a zinc price of US\$1.30 per pound, a molybdenum price of US\$14.00 per pound, a silver price of US\$25 per ounce, a gold price of US\$1,800 per ounce and a Canadian/U.S. dollar exchange rate of \$1.24.
4. After co-product and by-product margins.
5. Zinc unit costs are reported in U.S. dollars per payable pound of metal contained in concentrate. Zinc net cash unit costs are mine costs including adjusted cash cost of sales and smelter processing charges, less cash margins for by-products. Guidance for 2021 assumes a lead price of US\$1.00 per pound, a silver price of US\$25 per ounce and a Canadian/U.S. dollar exchange rate of \$1.24. By-products include both by-products and co-products.
6. Steelmaking coal unit costs are reported in Canadian dollars per tonne.
7. Non-GAAP financial measure. See "Non-GAAP Financial Measures" slides.

Slide 29: Capital Expenditures Guidance

1. As at July 26, 2021. See Teck's Q2 2021 press release for further details.
2. Steelmaking coal sustaining capital guidance for 2021 includes \$245 million of water treatment capital. 2020 includes \$267 million of water treatment capital.
3. Growth expenditures include RACE21™ capital expenditures for 2021 of \$150 million, of which \$30 million relates to copper, \$5 million relates to zinc, \$110 million relates to steelmaking coal, and \$5 million relates to corporate projects.
4. Copper growth guidance for 2021 includes studies for HVC 2040, Antamina, QB3, Zafrenal, San Nicolás and Galore Creek.

Slide 30: Commodity Price Leverage

1. As at July 26, 2021. The sensitivity of our annual profit attributable to shareholders and EBITDA to changes in the Canadian/U.S. dollar exchange rate and commodity prices, before pricing adjustments, based on our current balance sheet, our 2021 mid-range production estimates, current commodity prices and a Canadian/U.S. dollar exchange rate of \$1.25. See Teck's Q2 2021 press release for further details.
2. All production estimates are subject to change based on market and operating conditions.
3. The effect on our profit attributable to shareholders and on EBITDA of commodity price and exchange rate movements will vary from quarter to quarter depending on sales volumes. Our estimate of the sensitivity of profit and EBITDA to changes in the U.S. dollar exchange rate is sensitive to commodity price assumptions.
4. Zinc includes 295,000 tonnes of refined zinc and 617,500 tonnes of zinc contained in concentrate.
5. Bitumen volumes from our energy business unit.
6. Our WTI oil price sensitivity takes into account our interest in Fort Hills for respective change in revenue, partially offset by the effect of the change in diluent purchase costs as well as the effect on the change in operating costs across our business units, as our operations use a significant amount of diesel fuel.

ESG Leadership

Teck



Health, Safety, Environment and Communities Performance

Responding to COVID-19—Five Pillar Approach



Prevention



Employee Support



Communities & Public Health



Business Continuity



Communication

Prioritizing the health and safety of our people and communities

Health, Safety, Environment and Communities Performance

- Safety performance in H1 2021 vs. FY 2020
 - **38% reduction** in High-Potential Incidents
 - **26% decrease** in Lost-Time Injury Frequency
- Continued implementation of **High Potential Risk Program** to reduce the most significant risks
- 1 fatality in January 2021 following a fatality-free year in 2020. **Carried out in-depth investigation** to identify measures to prevent reoccurrence

Teck Operated Incident Frequency (per 200,000 hours worked)

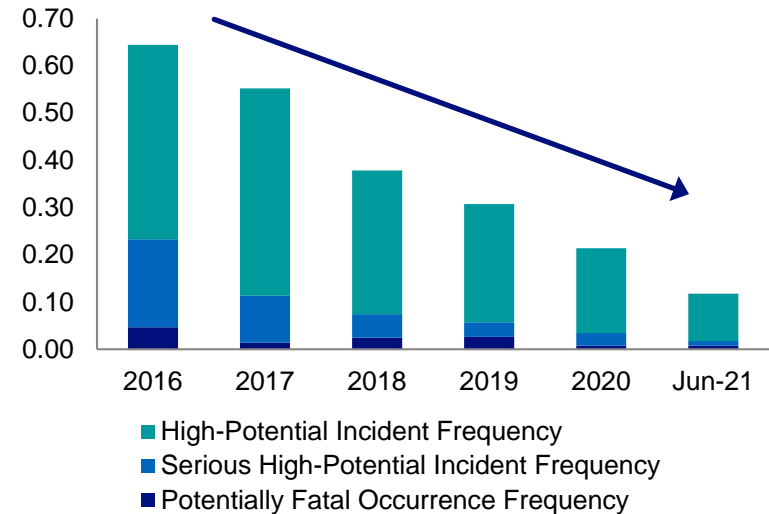

Overall, 80% reduction in High-Potential Incident Frequency from 2016 to June 2021



Health, Safety, Environment and Communities Performance

Communities



Engaging throughout the mining life-cycle to create lasting benefits

- **\$10.8 billion in economic benefits** generated in 2020
- **72% local employment** at operations
- Dedicated **\$20 million COVID-19 fund** to support local communities
- Global citizenship initiatives **Copper & Health** and **Zinc & Health**

Indigenous Peoples



Respect for culture and heritage; early engagement and focus on working to achieve Free, Prior and Informed Consent (FPIC)

- **72 active Indigenous agreements** covering all operations
- **\$192 million** spent with Indigenous businesses in 2020
- **Support for reconciliation:** Reconciliation Canada, Indian Residential School Society, Indspire youth bursary

Health, Safety, Environment and Communities Performance

Water



Working to protect water quality and reducing use in water-scarce regions.

- **Tripling** Elk Valley treatment capacity in 2021. Commissioned **20 M l/day Elkview SRF**
- Achieved **13%** reduction in freshwater use at Chilean operations
- Reused and recycled water at mining operations **3.3** times
- Constructing dedicated desalination plant at QB2

Tailings



Meeting global best practices for safety at our tailings facilities throughout their life-cycle

- **Fully applying GISTM** by August 2023
- All **active and closed** tailings facilities meet or exceed regulatory requirements
- **0** significant tailings-related environmental incidents in 2020 and to-date in 2021
- **100%** of facilities evaluated annually by a third-party Engineer of Record

Health, Safety, Environment and Communities Performance

Biodiversity & Reclamation



Working towards a net-positive impact on biodiversity

- **5,930 hectares** of cumulative land reclaimed to date
- Joint Management Agreement reached with the Ktunaxa Nation for over **7,000 hectares** of conservation lands
- Joined 1t.org Corporate Alliance to conserve, restore and grow **one trillion trees** by 2030

Responsible Production



Reducing waste and pollution and keeping materials in use

- **27,583 tonnes** of waste recycled in 2020
- **43,100 tonnes** of urban ore and secondary sources recycled at Trail Operations in 2020
- Piloting **blockchain-enabled product passport**

Health, Safety, Environment and Communities Performance

Inclusion, Equity & Diversity



Fostering a workplace where everyone is included, valued and equipped for today and the future

- Named to **Forbes World's Best Employers 2020**
- **20% women** in total Teck workforce, vs Bloomberg 2019 industry average of 15.7%
- **28% women** in senior management
- **One-third** of all new hires are women

Governance



Transparency and accountability to drive results for all our stakeholders

- **25%** of Teck's board of directors are women, above the Osler 2020 industry average in Canada of 16%
- **Executive remuneration** linked to HSEC performance through integration into corporate, business unit and personal components

Focus on Sustainability Leadership

Ambitious sustainability goals in eight strategic themes



Health and Safety

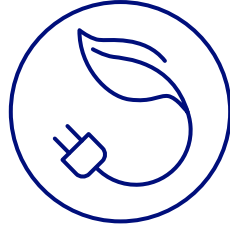

Climate Change

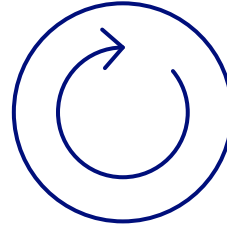

Responsible Production



Our People

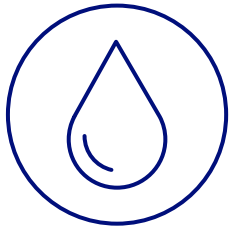

Water



Tailings Management



Communities and
Indigenous Peoples

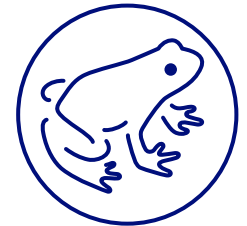

Biodiversity and
Reclamation

Climate Change

Starting from a strong position

Well-positioned
for a Low-Carbon
Economy



Among **lowest**
carbon intensity
miners globally



Carbon pricing
already built into
majority of business

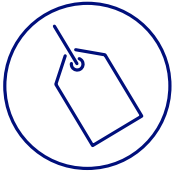

CO₂ Copper Intensity Curve (2020), t CO₂e/t Copper equivalent

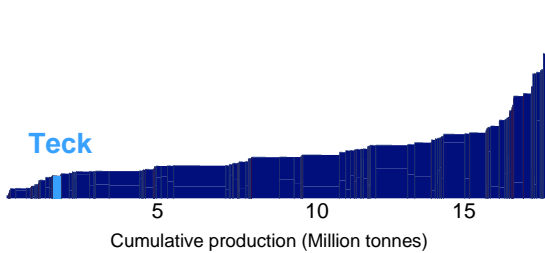

Copper

CO₂ Zinc Intensity Curve (2020), t CO₂e/t Zinc equivalent

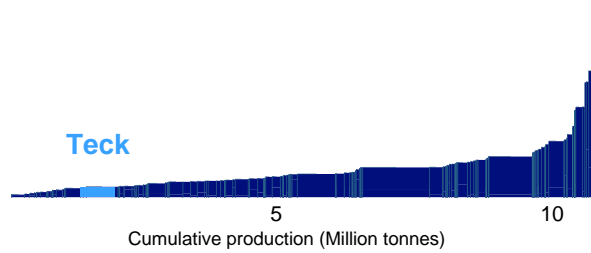

Zinc

CO₂ Coal Intensity Curve (2020), t CO₂e/t saleable coal

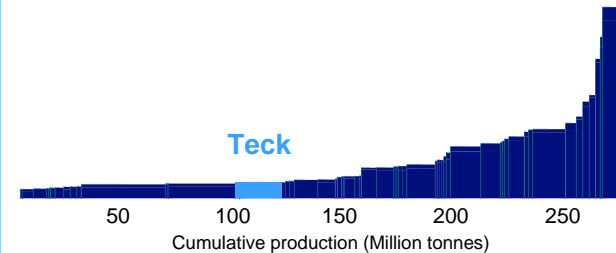

Steelmaking Coal

Low-quartile CO₂ emissions per tonne of copper, zinc and steelmaking coal production¹

Climate Change

Our climate strategy



Positioning Teck for a low-carbon economy

- Producing metals and minerals required for transition to a low-carbon economy
- Rebalancing portfolio towards copper
- Efficient, low-cost and low-carbon operations will keep Teck competitive



Support for appropriate carbon pricing policies

- We support broad-based effective carbon pricing
- Best method to encourage global action on climate change
- Work with associations/government on policy solutions to limit climate change to 1.5°C



Reducing our carbon footprint

Long-term targets:

- Carbon neutral by 2050
- Reduce carbon intensity of operations by 33% by 2030
- Work with customers and transportation providers to reduce downstream emissions



Adapting to the physical impacts of climate change

- Increase resilience of operations
- Incorporate climate scenarios into project design and mine closure planning

Climate Change

Our pathway to net zero

2020–2030: Target readily available;
cost-competitive technologies in these areas

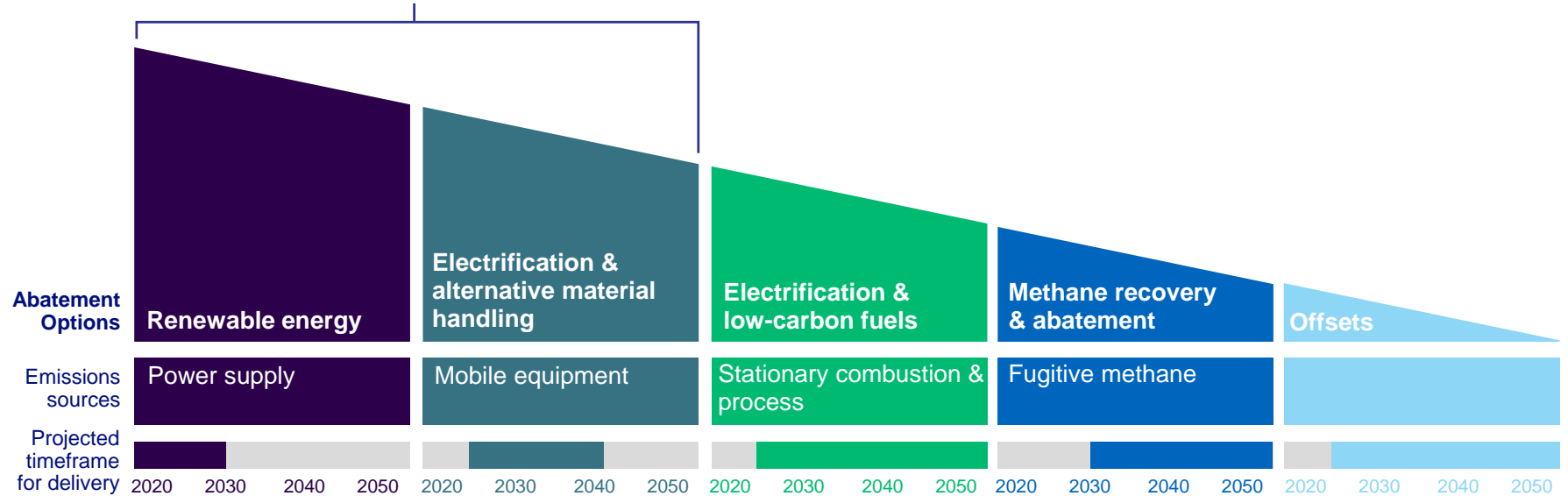

Sustainability Reporting and Rankings

Our Reporting Frameworks



GRI Standards



SASB Standards



Task Force on Climate Related Financial Disclosures (TCFD)

Industry Groups



Towards Sustainable Mining
Vers le développement minier durable



ESG Rankings



Top-ranked mining company
World & North American Indices
Gold Class Award 2021



Top ranked North American company



FTSE4Good

Top percentile, mining subsector



“A” rating since 2013

Outperforming 4 of 5 largest peers



Ranked among the top 10% of Metals & Mining companies



Top ranked diversified metals mining company

ESG Resources for Investors

Holistic reporting suite

- Sustainability reporting for **20 years** in Core accordance with the **Global Reporting Initiative (GRI) Standards** and G4 Mining and Metals Sector Disclosures
- Sustainability Report is aligned with **Sustainability Accounting Standards Board (SASB)**
- **Task Force for Climate-Related Financial Disclosure (TCFD) aligned report** “Climate Change Outlook 2021”
- Separate **data download** with ESG data of interest to investment community

Please see our [Disclosure Portal](#) and [Sustainability Information for Investors](#)

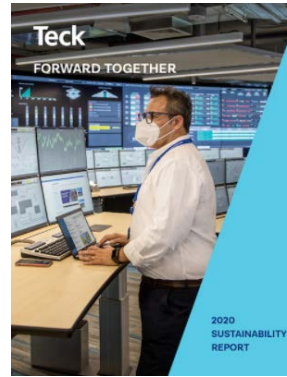
The cover of the Teck ESG Investor Download report features a table of ESG data. The text "Teck ESG Investor Download" is at the top, followed by a disclaimer and the text "All figures in US\$".

Year	2019	2020	2021	2022
Operating Income	1,000	1,000	1,000	1,000
Operating Expenses	(800)	(800)	(800)	(800)
Operating Profit	200	200	200	200
Operating Profit Margin	20%	20%	20%	20%
Operating Profit per Share	1.00	1.00	1.00	1.00
Operating Profit per Share (Diluted)	0.90	0.90	0.90	0.90
Operating Profit per Share (Adjusted)	1.10	1.10	1.10	1.10
Operating Profit per Share (Adjusted) (Diluted)	1.00	1.00	1.00	1.00
Operating Profit per Share (Adjusted) (Diluted) (Excluding Non-Recurring Items)	1.20	1.20	1.20	1.20
Operating Profit per Share (Adjusted) (Diluted) (Excluding Non-Recurring Items) (Excluding Goodwill Impairment)	1.30	1.30	1.30	1.30
Operating Profit per Share (Adjusted) (Diluted) (Excluding Non-Recurring Items) (Excluding Goodwill Impairment) (Excluding Restructuring Costs)	1.40	1.40	1.40	1.40
Operating Profit per Share (Adjusted) (Diluted) (Excluding Non-Recurring Items) (Excluding Goodwill Impairment) (Excluding Restructuring Costs) (Excluding Other Non-Recurring Items)	1.50	1.50	1.50	1.50
Operating Profit per Share (Adjusted) (Diluted) (Excluding Non-Recurring Items) (Excluding Goodwill Impairment) (Excluding Restructuring Costs) (Excluding Other Non-Recurring Items) (Excluding Other Non-Recurring Items)	1.60	1.60	1.60	1.60
Operating Profit per Share (Adjusted) (Diluted) (Excluding Non-Recurring Items) (Excluding Goodwill Impairment) (Excluding Restructuring Costs) (Excluding Other Non-Recurring Items) (Excluding Other Non-Recurring Items) (Excluding Other Non-Recurring Items)	1.70	1.70	1.70	1.70
Operating Profit per Share (Adjusted) (Diluted) (Excluding Non-Recurring Items) (Excluding Goodwill Impairment) (Excluding Restructuring Costs) (Excluding Other Non-Recurring Items) (Excluding Other Non-Recurring Items) (Excluding Other Non-Recurring Items) (Excluding Other Non-Recurring Items)	1.80	1.80	1.80	1.80
Operating Profit per Share (Adjusted) (Diluted) (Excluding Non-Recurring Items) (Excluding Goodwill Impairment) (Excluding Restructuring Costs) (Excluding Other Non-Recurring Items) (Excluding Other Non-Recurring Items) (Excluding Other Non-Recurring Items) (Excluding Other Non-Recurring Items) (Excluding Other Non-Recurring Items)	1.90	1.90	1.90	1.90
Operating Profit per Share (Adjusted) (Diluted) (Excluding Non-Recurring Items) (Excluding Goodwill Impairment) (Excluding Restructuring Costs) (Excluding Other Non-Recurring Items) (Excluding Other Non-Recurring Items) (Excluding Other Non-Recurring Items) (Excluding Other Non-Recurring Items) (Excluding Other Non-Recurring Items) (Excluding Other Non-Recurring Items)	2.00	2.00	2.00	2.00

The Teck logo is at the bottom right.

Near-Term Copper Growth - QB2 Project

Photo: Concentrator, August 2021



QB2 Project

Executing on a world class development asset

Highlights

- ✓ Vast, long life deposit
- ✓ Very low strip ratio
- ✓ Low all in sustaining costs (AISC)¹
- ✓ Potential to be a top 20 producer
- ✓ High grade, clean concentrates
- ✓ Significant brownfield development
- ✓ Community agreements in place and strong local relationships
- ✓ Project has surpassed the halfway point
- ✓ Expansion potential (QB3) with potential to be a top 5 producer

Location

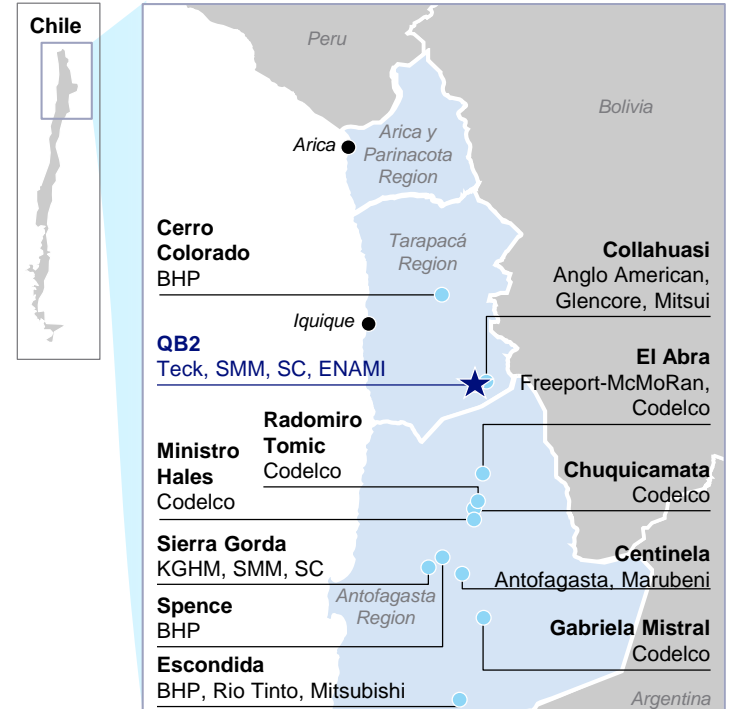

QB2 Update

Positioning for successful start-up

Operational Readiness and Commissioning

- Focus to ensure a seamless transition to operations
- Integrated Operations and Business Partner Model
- Operations leadership team in place and ramping up workforce

Operational Areas

- Open pit mine (120Mtpa peak)
- Concentrator (143ktpd)
- Tailings management facility (1.4Bt capacity)
- Concentrate and water supply pipelines (165km)
- Port facility (including a desalination plant and concentrate filtration plant)

Driving value by linking people, process,
and workplace design

Remote Integrated Operations Centre

Located in Santiago and opened in Q1 2020

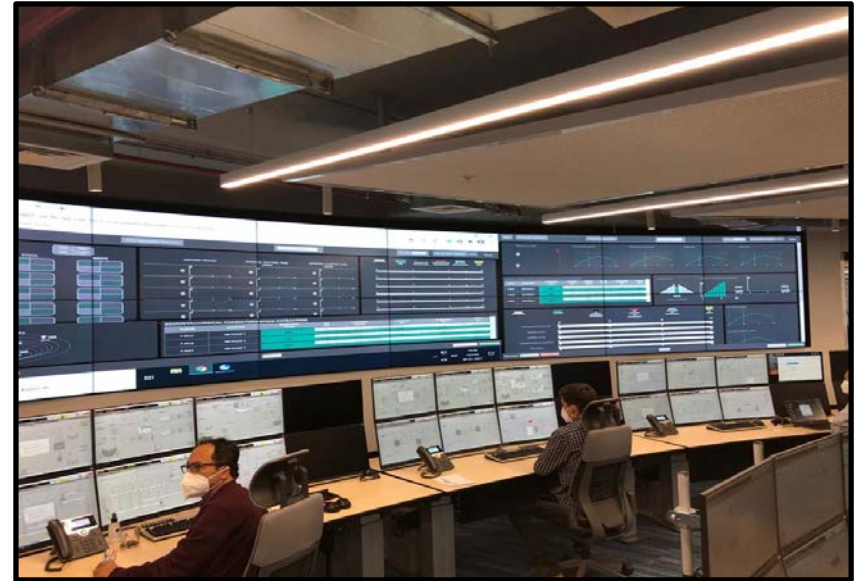

QB2 Update

Keys to delivering first copper

Alignment with Bechtel and Contractors

Executing on the Critical Path at Concentrator

- Line 1 grinding and flotation drive first copper
- Followed by Line 2 and subsystems (i.e. moly plant, pebble crushers)

Port to Pond - Enablers for Start-up

- Energization of the electrical grid
- Early commissioning of the desal plant
- Delivering water to the pond ahead of final dam completion

Commissioning of AHS Fleet

CAT 794 on AHS calibration pad



Partnership with Bechtel key success factor through completion

QB2's Competitive Cost Position

Competitive Operating Cost & Capital Intensity

- Given the exceptionally low strip ratio, consistent grade profile, compact site layout, and high level of automation, QB2 is expected to have attractive and relatively stable operating costs
- Exceptional strip ratio of 0.70 LOM, meaning for every one tonne of ore mined, only 0.70 tonnes of waste need to be mined (0.44 over first 5 full years)
 - Compares to other world class asset strip ratios of 2.6 for Escondida, 3.0 for Antamina, and 3.7 for Collahuasi¹
 - Major benefit to sustaining capital since it reduces mobile fleet size and replacement costs

Low Cash Cost Position

C1 Cash Cost² & AISC³ Curve¹ (US\$/lb, 2023E)

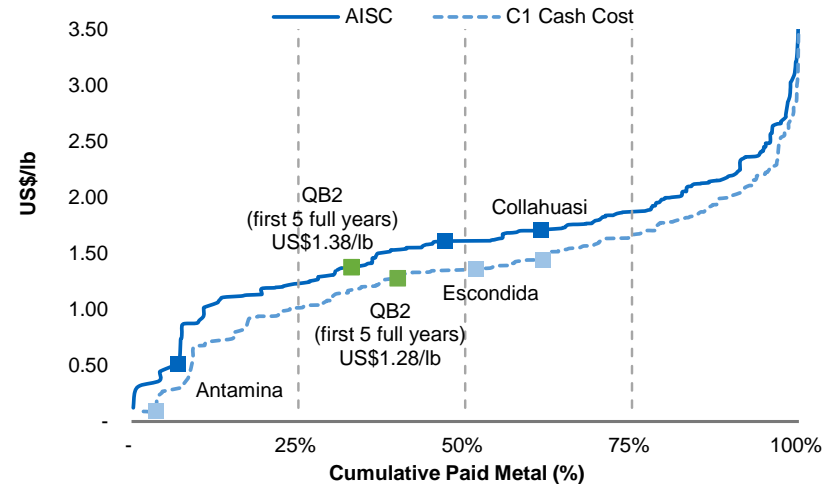

Based on Sanction Case (Including 199 Mt Inferred Resources)

Refer to “QB2 Project Economics Comparison” and “QB2 Reserves and Resources Comparison” slides for Reserve Case (Excluding Inferred Resources)

The description of the QB2 project Sanction Case includes inferred resources that are considered too speculative geologically to have the economic considerations applied to them that would enable them to be categorized as mineral reserves. Inferred resources are subject to greater uncertainty than measured or indicated resources and it cannot be assumed that they will be successfully upgraded to measured and indicated through further drilling.

Vast, Long Life Deposit at Quebrada Blanca

- QB2 uses only ~18% of the 2020 reserve and resource tonnage¹
- Deposit is capable of supporting a very long mine life based on throughput rate of 143 ktpd² by utilizing further tailings capacity at already identified sites
- Actively evaluating potential options to exploit value of full resource through mill expansion and / or mine life extension
- Beyond the extensive upside included in the defined QB deposit, the district geology is highly prospective for exploration discovery and resource addition; mineralization is open in multiple directions

Based on Sanction Case (Including 199 Mt Inferred Resources)

Refer to “QB2 Project Economics Comparison” and “QB2 Reserves and Resources Comparison” slides for Reserve Case (Excluding Inferred Resources)

The description of the QB2 project Sanction Case includes inferred resources that are considered too speculative geologically to have the economic considerations applied to them that would enable them to be categorized as mineral reserves. Inferred resources are subject to greater uncertainty than measured or indicated resources and it cannot be assumed that they will be successfully upgraded to measured and indicated through further drilling.

Significant extension potential

Reserve and Resource Tonnage (Mt)

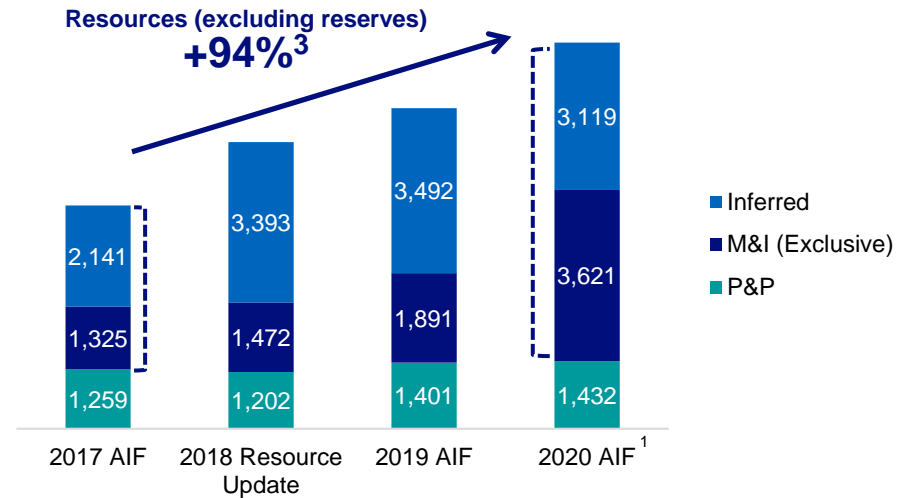

QB2 Funding Model

Minimized Teck execution funding through partnership and project finance

QB2 Funding Model - Post January 2019 (US\$B)

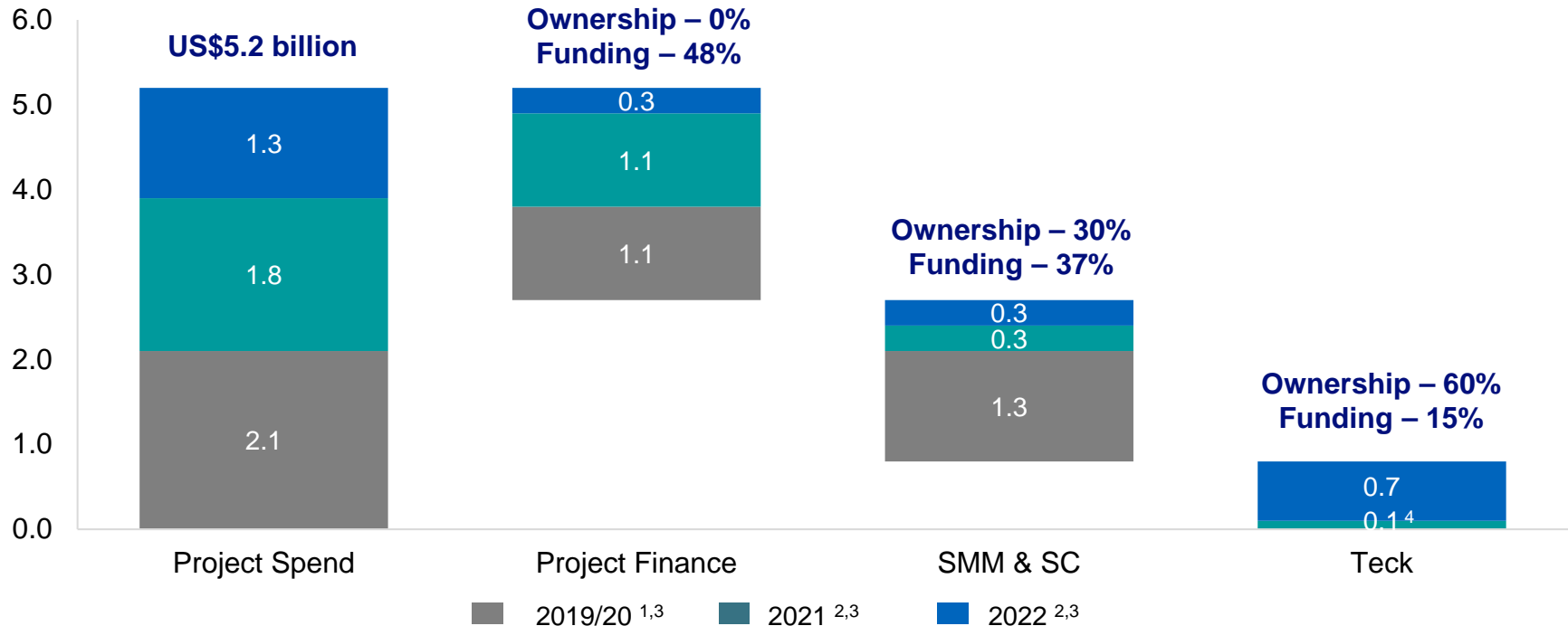

QB2 Project Finance Facility

- Senior debt will continue to be drawn pro-rata under a pre-determined Senior Debt-to-Shareholder funding ratio until US\$2.5 billion is drawn
- Pre-completion, senior debt is guaranteed on a pro-rata basis (after consideration of ENAMI's 10% carried interest)
 - Teck 66.67% / SMM 27.77% / SC 5.56%
- Senior debt becomes non-recourse after successfully achieving operational completion tests
- Semi-annual amortization payments of US\$147 million will begin no later than June 15, 2023; facility matures in 2031
- The facility requires partial debt repayment upon dividend distribution to equity partners



ENAMI Interest in Quebrada Blanca

- The government of Chile owns a 10% non-funding interest in Compañía Minera Teck Quebrada Blanca S.A. (CMTQB) through its state-run minerals company, Empresa Nacional de Minería (ENAMI)
- ENAMI has been a partner at QB since 1989 and is a 10% shareholder of Carmen de Andacollo
- ENAMI is not required to fund QB2 development costs
- Project equity funding in form of:
 - 25% Series A Shares
 - 75% Shareholder Loans
- Until shareholder loans are fully repaid, ENAMI is entitled to a minimum dividend, based on net income, that approximates 2.0-2.5% of free cash flow
 - Thereafter, ENAMI receives 10% of dividends / free cash flow

Organizational Chart

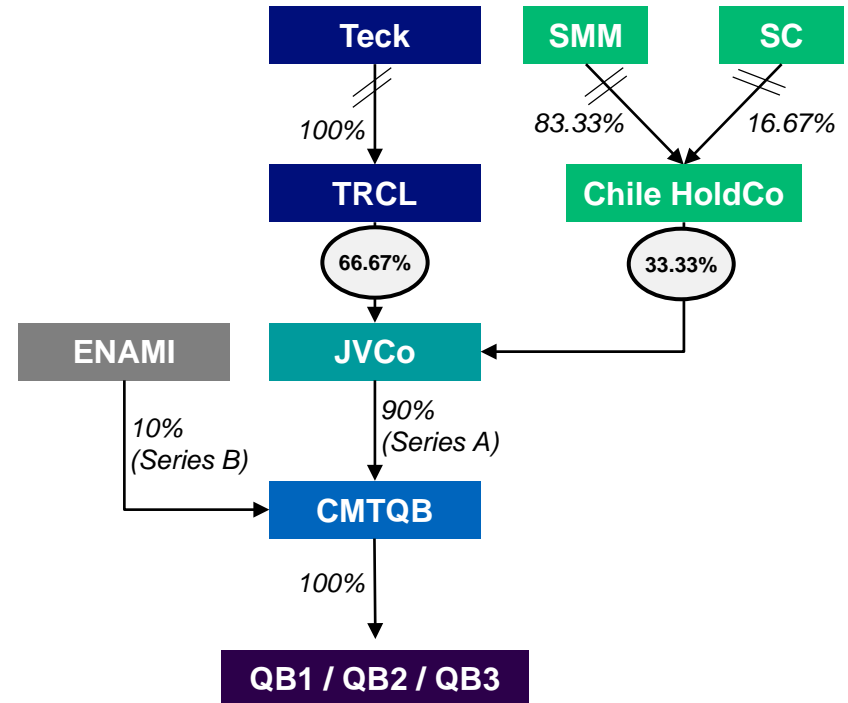

Quebrada Blanca Accounting Treatment

Balance Sheet

- 100% of project spending included in property, plant and equipment
- Debt includes 100% of project financing
- Total shareholder funding to be split between loans and equity approximately 75%/25% over the life of the project
- Sumitomo (SMM/SC)¹ contributions will be shown as advances as a non-current liability and non-controlling interest as part of equity
- Teck contributions, whether debt or equity, eliminated on consolidation

Income Statement

- Teck's income statement will include 100% of QB's revenues and expenses
- Sumitomo's¹ 30% and ENAMI's 10% share of profit will show as profit attributable to non-controlling interests

Cash Flow

- 100% of project spending included in capital expenditures
- Sumitomo¹ contribution recorded within financing activities and split approximately 75%/25% as:
 - Loans recorded as “Advances from Sumitomo”
 - Equity recorded as “Contributions from Non-Controlling Interests”
- 100% of draws on project financing included in financing activities
- After start-up of operations
 - 100% of profit in cash flow from operations
 - Sumitomo's¹ 30% and ENAMI's 10% share of distributions included in non-controlling interest

QB2 Project Economics Comparison

		Reserve Case ¹	Sanction Case ²
Mine Life	Years	28	28
Strip Ratio			
First 5 Full Years		0.16	0.44
LOM ³		0.41	0.70
C1 Cash Cost ⁴			
First 5 Full Years	US\$/lb	\$1.29	\$1.28
LOM ³	US\$/lb	\$1.47	\$1.37
AISC ⁵			
First 5 Full Years	US\$/lb	\$1.40	\$1.38
LOM ³	US\$/lb	\$1.53	\$1.42

QB2 Reserves and Resources Comparison

Reserve Case (as at Nov. 30, 2018)^{1,2}

Reserves	Mt	Cu Grade %	Mo Grade %	Silver Grade ppm
Proven	476	0.51	0.018	1.40
Probable	924	0.47	0.019	1.25
Reserves	1,400	0.48	0.018	1.30

Resources (Exclusive of Reserves) ³	Mt	Cu Grade %	Mo Grade %	Silver Grade ppm
Measured	36	0.42	0.014	1.23
Indicated	1,558	0.40	0.016	1.14
M&I (Exclusive)	1,594	0.40	0.016	1.14
Inferred	3,125	0.38	0.018	1.15

Sanction Case (as at Nov. 30, 2018)^{2,4}

Reserves	Mt	Cu Grade %	Mo Grade %	Silver Grade ppm
Proven	409	0.54	0.019	1.47
Probable	793	0.51	0.021	1.34
Reserves	1,202	0.52	0.020	1.38

Resources (Exclusive of Reserves) ⁵	Mt	Cu Grade %	Mo Grade %	Silver Grade ppm
Measured	36	0.42	0.014	1.23
Indicated	1,436	0.40	0.016	1.13
M&I (Exclusive)	1,472	0.40	0.016	1.14
Inferred	3,194	0.37	0.017	1.13
+ Inferred in SC pit	199	0.53	0.022	1.21

Endnotes: Near-Term Copper Growth - QB2 Project

Slide 50: QB2 Project

1. All-in sustaining costs (AISC) are net cash unit costs (also known as C1 cash costs) plus sustaining capital expenditures. Net cash unit costs are calculated after cash margin by-product credits assuming US\$10.00/lb molybdenum and US\$18.00/oz silver. Net cash unit costs for QB2 include stripping costs during operations. AISC, Net cash unit cost and cash margins for by-products are non-GAAP financial measures which do not have a standardized meanings prescribed by International Financial Reporting Standards (IFRS) or Generally Accepted Accounting Principles in the United States. These measures may differ from those used by other issuers and may not be comparable to such measures as reported by others. These measures are meant to provide further information about our financial expectations to investors. These measures should not be considered in isolation or used to substitute for other measures of performance prepared in accordance with IFRS. For more information on our calculation of non-GAAP financial measures please see our Management's Discussion and Analysis for the year ended December 31, 2018, which can be found under our profile on SEDAR at www.sedar.com.

Slide 53: QB2's Competitive Cost Position

1. Source: Wood Mackenzie. Average 2021-2040.
2. C1 cash costs (also known as net cash unit costs) are presented after by-product credits assuming US\$10.00/lb molybdenum and US\$18.00/oz silver. C1 cash costs for QB2 include stripping costs during operations. Net cash unit costs and C1 cash costs are non-GAAP financial measures. See "Non-GAAP Financial Measures" slides.
3. All-in sustaining costs (AISC) are net cash unit costs (also known as C1 cash costs) plus sustaining capital expenditures. Net cash unit costs are calculated after cash margin by-product credits assuming US\$10.00/lb molybdenum and US\$18.00/oz silver. Net cash unit costs for QB2 include stripping costs during operations. AISC, net cash unit cost and cash margins for by-products are non-GAAP financial measures. See "Non-GAAP Financial Measures" slides.

Slide 54: Vast, Long Life Deposit at Quebrada Blanca

1. Reserves and resources as at December 31, 2020.
2. Based on Sanction Case mine plan tonnage.
3. Resources are reported separately from, and do not include that portion of resources classified as reserves.

Slide 55: QB2 Funding Model

1. Excludes working capital, interest, and COVID-19 capital, includes escalation and contingency, at actual CLP exchange rate.
2. Excludes working capital, interest, and COVID-19 capital, includes escalation and contingency, at 775 CLP exchange rate.
3. Assumes 100% of project finance and partner funding is attributed towards capital spend versus working capital, interest and COVID-19 costs.
4. 2019-2021.

Slide 58: Quebrada Blanca Accounting Treatment

1. Sumitomo Metal Mining Co. Ltd. and Sumitomo Corporation are collectively referred to as Sumitomo.

Slide 59: QB2 Project Economics Comparison

1. Based on go-forward cash flow from January 1, 2017. Based on all equity funding structure.
2. Based on go-forward cash flow from January 1, 2019. Based on optimized funding structure.
3. Life of Mine annual average figures exclude the first and last partial years of operations.
4. C1 cash costs are presented after by-product credits assuming US\$10.00/lb molybdenum and US\$18.00/oz silver. Net cash unit costs are consistent with C1 cash costs. C1 cash costs for QB2 include stripping costs during operations. Net cash unit costs and C1 cash costs are non-GAAP financial measures. See "Non-GAAP Financial Measures" slides.
5. All-in sustaining costs (AISC) are net cash unit costs (also known as C1 cash costs) plus sustaining capital expenditures. Net cash unit costs are calculated after cash margin by-product credits assuming US\$10.00/lb molybdenum and US\$18.00/oz silver. Net cash unit costs for QB2 include stripping costs during operations. AISC, net cash unit cost and cash margins for by-products are non-GAAP financial measures. See "Non-GAAP Financial Measures" slides.

Endnotes: Near-Term Copper Growth - QB2 Project

Slide 60: QB2 Reserves and Resources Comparison

1. Mineral reserves are constrained within an optimized pit shell and scheduled using a variable grade cut-off approach based on NSR cut-off US\$13.39/t over the planned life of mine. The life-of-mine strip ratio is 0.41.
2. Both mineral resource and mineral reserve estimates assume long-term commodity prices of US\$3.00/lb Cu, US\$9.40/lb Mo and US\$18.00/oz Ag and other assumptions that include: pit slope angles of 30–44°, variable metallurgical recoveries that average approximately 91% for Cu and 74% for Mo and operational costs supported by the Feasibility Study as revised and updated.
3. Mineral resources are reported using a NSR cut-off of US\$11.00/t and include 23.8 million tonnes of hypogene material grading 0.54% copper that has been mined and stockpiled during existing supergene operations.
4. Mineral reserves are constrained within an optimized pit shell and scheduled using a variable grade cut-off approach based on NSR cut-off US\$18.95/t over the planned life of mine. The life-of-mine strip ratio is 0.70.
5. Mineral resources are reported using a NSR cut-off of US\$11.00/t outside of the reserves pit. Mineral resources include inferred resources within the reserves pit at a US\$ 18.95/t NSR cut-off and also include 23.8 million tonnes of hypogene material grading 0.54% copper that has been mined and stockpiled during existing supergene operations.

Copper Growth Strategy

Teck



Right Approach: Portfolio of Copper Growth Options

Value realization through production or M&A

Teck is positioned to realize value from a robust pipeline of copper projects

- Investment in exploration and strategic M&A over the last 20 years has secured quality opportunities
- Focus on integrated technical, social, environmental and commercial de-risking of opportunities
- Leadership, experience and systems in place to fulfill strategy

We seek to maximize shareholder returns and maintain a strong balance sheet

- Reduce Teck's equity requirements through partnering, streams, infrastructure carve-outs and project financing
- Maintain investment grade metrics to support strong liquidity
- Rigorous capital allocation framework to balance growth and cash returns

QB2 Case Study

De-risked at project sanction:

- ~80% engineered and >70% procured
- Key permits approved

Reduced equity requirements:

- US\$1.2B transaction payment received
- Partnership further reduced Teck's funding
- US\$2.5B project finance

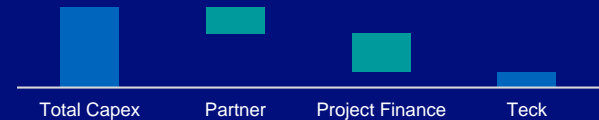

Right sized balance sheet:

- Repaid US\$4B in debt¹ and regained investment grade rating

Return of capital to shareholders:

- C\$1.2B of share buy backs and ~C\$700M in dividends²

Right Approach: Actively Strengthening our Portfolio

Prudent investments in near-term, medium-term, and future growth options



Teck's copper growth portfolio is supported by recent and extensive studies



Holistic portfolio approach to capital allocation



Continue to increase the quality of our medium-term and future potential growth options

Teck is positioned to maximize value from copper demand growth well beyond the ramp-up of QB2

		2017	2021
Near Term	Zafranal Cu-Au	<i>Prefeasibility</i>	Feasibility (Q2 2019) SEIA submission in H2 2021
	San Nicolás Cu-Zn-Au-Ag	<i>Scoping</i>	Prefeasibility (Q1 2021) EIA submission-ready
Medium Term	QB3 Cu-Mo-Ag	<i>Identifying resource upside</i>	Preparing for Prefeasibility 94% growth in QB Resource
	Galore Creek Cu-Au-Ag	<i>Asset management</i>	Initiated Prefeasibility Leveraging existing permits
Future Potential	NuevaUnión Cu-Au-Mo	<i>Prefeasibility</i>	Feasibility completed (2020) EIA submission-ready
	Mesaba Cu-Ni-PGM	<i>Scoping and concept studies</i>	Preparing for Prefeasibility Environmental Baseline District Assessment
	Schaft Creek Cu-Mo-Au-Ag	<i>Feasibility (2013 Copper Fox)</i>	Scoping update (2020)

Right Assets: Portfolio of Copper Growth Options

Value optionality guided by commercial discipline

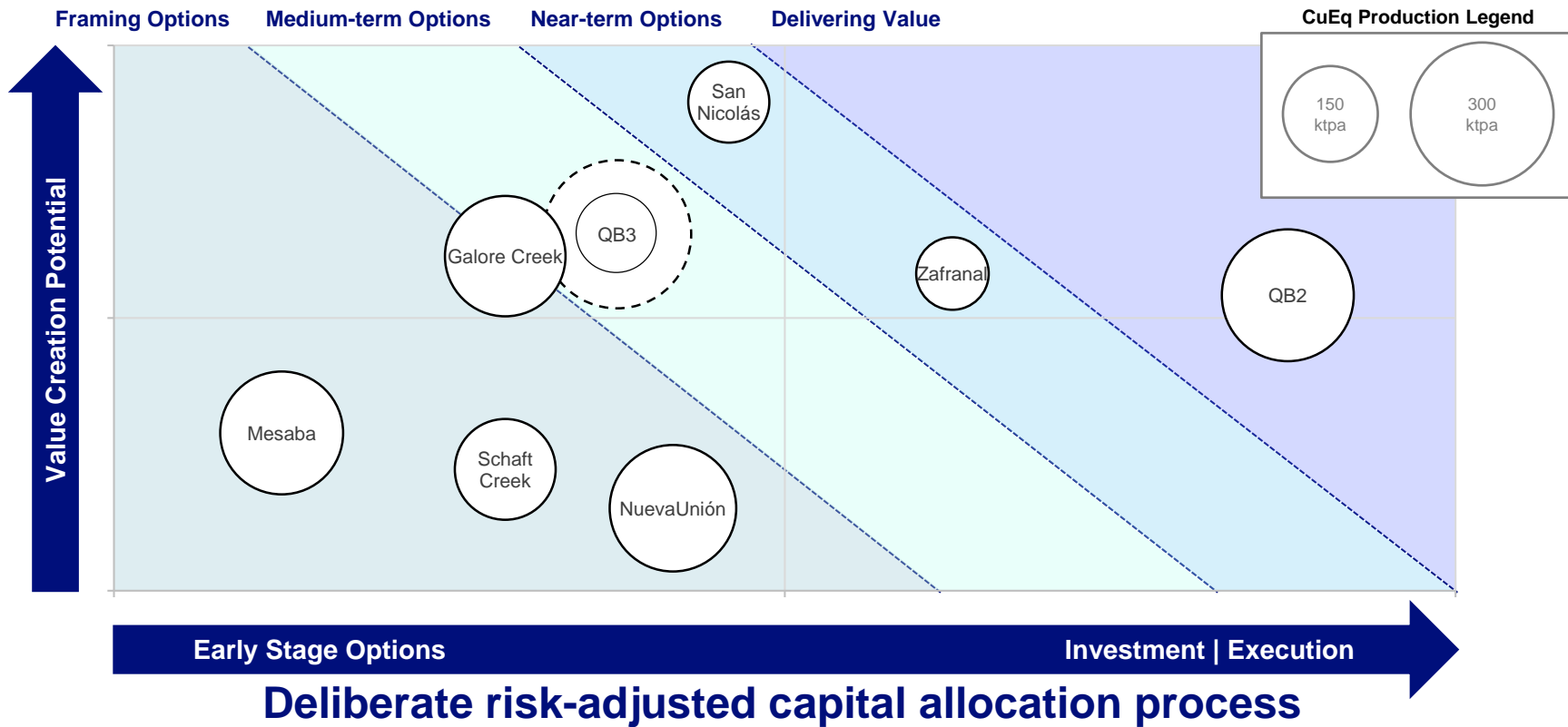

Zafranal Cu-Au Porphyry (80%)

Feasibility complete, SEIA submission in H2 2021¹

Peru



Long Life Asset

- 19 year mine life with mine life extension opportunities through pit expansion and district resource development



Quality Investment

- Attractive front-end grade profile
- Mid cost curve forecast LOM C1 cash costs²
- Competitive capital intensity



Mining Jurisdiction

- Strong support from Peruvian regulators including MINEM and SENACE
- Engaged with all communities

Path to Value Realization:

- Continue prudent investments to de-risk the project improving capital and operating costs
- SEIA submission in H2 2021

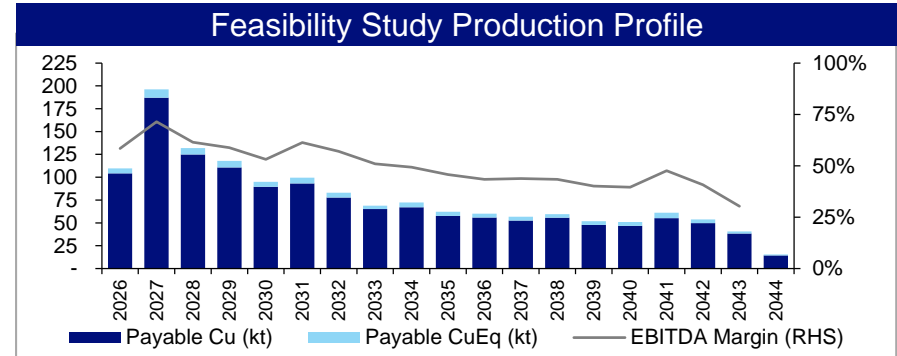

Initial Capex US\$1.23B	Payback Period 2.3 Years	After-Tax NPV₈ US\$1.0B	After-Tax IRR 23.3%
Avg 1st 5 year³ Production 125 kt Cu 42 koz Au	Avg 1st 5 year³ EBITDA² US\$0.6B	Avg 1st 5 year³ C1 Cash Cost² US\$1.18/lb	Avg 1st 5 year³ Head Grade 0.57% Cu

Metal price assumptions: US\$3.50/lb Cu; US\$1,400/oz Au

Illustrative Timeline

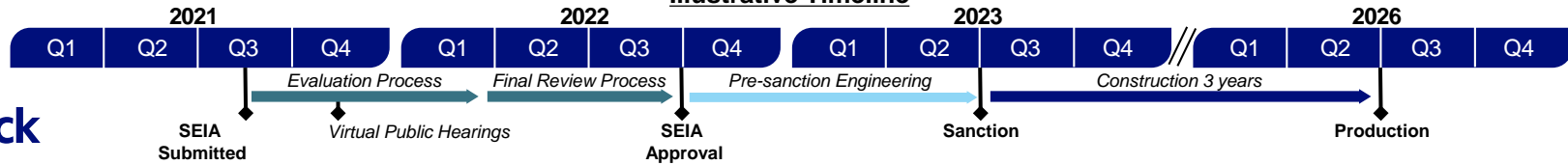

San Nicolás Cu-Zn (Ag-Au) VHMS (100%)

Prefeasibility and Environmental Impact Assessment completed¹

Mexico



Long Life Asset

- One of the world's most significant undeveloped VHMS deposits
- Updated Resources Statement



Quality Investment

- Expect C1 cash costs² in the 1st quartile
- Competitive capital intensity
- Co-product Zn and Au & Ag credits



Mining Jurisdiction

- Well-established mining district in Mexico
- Community engagement well underway

Path to Value Realization:

- Prefeasibility and EIA completed in Q1 2021 and Q3 2021
- Assessing partnering and development options

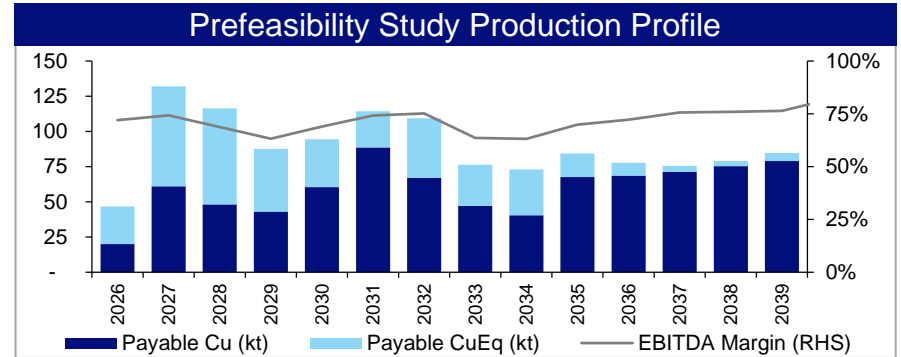

Initial Capex US\$842M	Payback Period 2.6 Years	After-Tax NPV₈ US\$1.5B	After-Tax IRR 32.5%
Avg 1st 5 year³ Production 63 kt Cu, 147 kt Zn, 31 koz Au	Avg 1st 5 year³ EBITDA² US\$0.5B	Avg 1st 5 year³ C1 Cash Cost² US\$(0.13)/lb	Avg 1st 5 year³ Head Grade 1.07% Cu

Metal price assumptions: US\$3.50/lb Cu, US\$1.15/lb Zn, US\$1,400/oz Au and US\$18/oz Ag

Illustrative Timeline

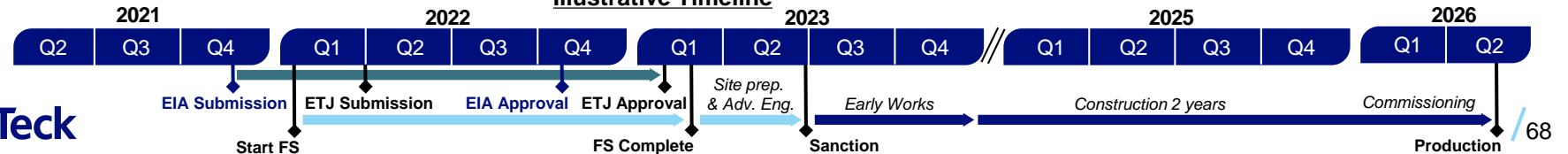

Medium-Term Development Options

Chile and Canada

Partnerships reduce capital needs | Options allow more flexible capital allocation

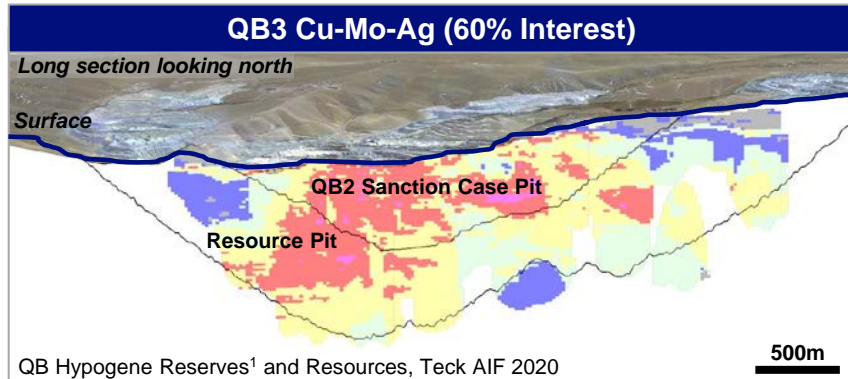

<p>Production Potential</p> <ul style="list-style-type: none"> Evaluating 50% to 200% increase in addition to QB2 	<p>Cost Position</p> <ul style="list-style-type: none"> Highly competitive 	<p>Resources^{3,4}</p> <ul style="list-style-type: none"> M&I 3.6 Bt 0.37% Cu, 0.016% Mo, 1.1g/t Ag Inf 3.1Bt 0.35% Cu, 0.017% Mo, 1.1g/t Ag
---	--	---

<p>Permitting</p> <ul style="list-style-type: none"> Environmental, social and regulatory programs in place 	<p>Capital Intensity</p> <ul style="list-style-type: none"> Low to medium due to brownfield Reduced execution / operational risk 	<p>Timetable</p> <ul style="list-style-type: none"> Right-size expansion and preparing for prefeasibility
---	---	---

Preparing for prefeasibility and leveraging QB2 ESG Platform

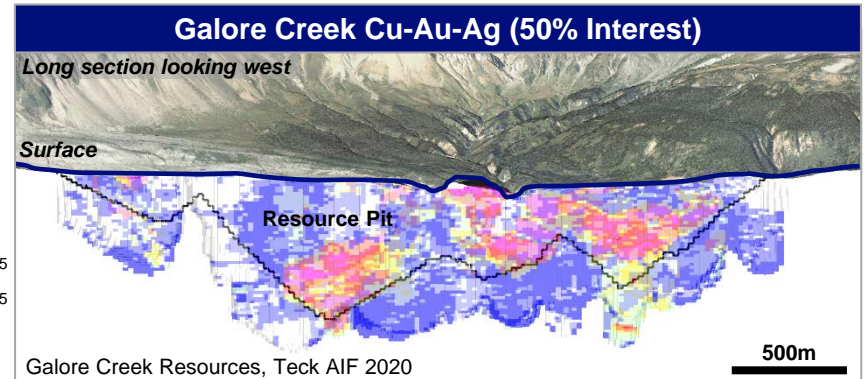

<p>Production Potential⁵</p> <ul style="list-style-type: none"> 179 ktpa Cu 224 koz/pa Au and 4.01 Moz/pa Ag 	<p>Cost Position²</p> <ul style="list-style-type: none"> LOM C1 Cost US\$0.65-0.75/lb Cu Notable Au and Ag by-product credits 	<p>Resources^{6,7,8}</p> <ul style="list-style-type: none"> M&I 1.1 Bt 0.47% Cu, 0.26 g/t Au, 4.2 g/t Ag Inf 0.2 Bt 0.27% Cu, 0.21 g/t Au, 2.7 g/t Ag
--	---	--

<p>Permitting</p> <ul style="list-style-type: none"> Leveraging existing permits Tahltan / regulator engagement 	<p>Capital Intensity</p> <ul style="list-style-type: none"> Low to medium due to high grade resource & significant past investment 	<p>Timetable</p> <ul style="list-style-type: none"> Complete prefeasibility in H1 2023
--	--	--

Initiating prefeasibility and reducing access cost and risk

Right Assets: Portfolio of Copper Growth Options

Multiple high quality copper options

Near Term Options

- | | |
|--|---------------------------|
| 1 Zafranal (Cu-Au), Peru^{1,2} | Teck 80% MMC 20% |
| Feasibility Study complete; SEIA submission in H2 2021
First five years: 133 ktpa CuEq; C1 Costs US\$1.18/lb Cu. US\$1.2B capex; NPV _g US\$1,026M; IRR 23.3% | |
| 2 San Nicolás (Cu-Zn-Au-Ag), Mexico^{1,2} | Teck 100% |
| Prefeasibility Study complete Q1 2021
First five years: 125 ktpa CuEq; C1 Costs (US\$0.18)/lb Cu. US\$0.8B capex; NPV _g US\$1,499M; IRR 34.0% | |

Medium Term Options

- | | |
|--|--|
| 3 QB3 (Cu-Ag-Mo), Chile^{1,3} | Teck 60% SMM/SC 30% ENAMI 10% |
| Prefeasibility Study stage; Various scenarios: Potential 348 - 624ktpa CuEq; Highly competitive C1 costs | |
| 4 Galore Creek (Cu-Au-Ag), BC, Canada¹ | Teck 50% Newmont 50% |
| Prefeasibility Study stage; Potential 230 ktpa CuEq; C1 Costs of US\$0.65-0.75/lb Cu | |

Future Potential

- | | |
|---|----------------------------------|
| 5 NuevaUnión (Cu-Au-Ag-Mo), Chile¹ | Teck 50% Newmont 50% |
| Feasibility Study being optimized; Potential 254 ktpa CuEq; C1 Costs of US\$1.00-1.10/lb Cu | |
| 6 Mesaba (Cu-Ni, PGM-Co), Minnesota, USA¹ | Teck 100% |
| Scoping study complete; Potential 239 ktpa CuEq; C1 Costs US\$0.80-0.90/lb Cu | |
| 7 Schaft Creek (Cu-Mo-Au-Ag), BC, Canada¹ | Teck 75% Coppel Fox 25% |
| Scoping Study being updated; Potential 161 ktpa CuEq; C1 Costs US\$0.60-0.70/lb Cu | |

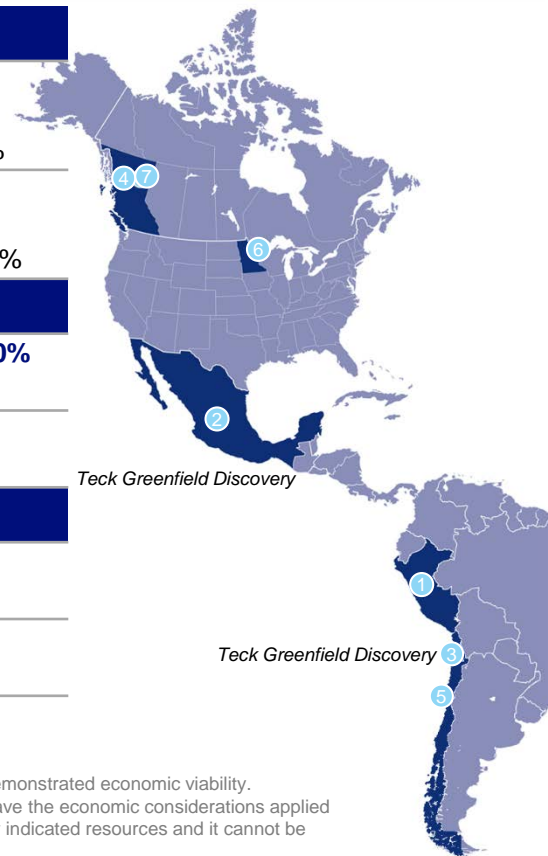

This slide discloses the results of economic analysis of mineral resources. Mineral resources that are not mineral reserves and do not have demonstrated economic viability. Projections for QB3, Galore Creek, Mesaba and Schaft Creek include inferred resources that are considered too speculative geologically to have the economic considerations applied to them that would enable them to be categorized as mineral reserves. Inferred resources are subject to greater uncertainty than measured or indicated resources and it cannot be assumed that they will be successfully upgraded to measured and indicated through further drilling.

Endnotes: Copper Growth Strategy

Slide 64: Right Approach: Portfolio of Copper Growth Options - Value realization through production or M&A

1. Total debt repayment between Q4 2015 and Q3 2019.
2. Share buybacks and dividends since Q4 2017 (one year prior to project sanction).

Slide 65: Right Assets: Portfolio of Copper Growth Options - Value optionality guided by commercial discipline

1. CuEq calculated with price assumptions: US\$3.50/lb Cu; US\$1.15/lb Zn; US\$6.90/lb Ni; US\$21/lb Co; US\$10/lb Mo; US\$1,400/oz Au; US\$18/oz Ag; US\$1,300/oz Pd; \$1,200/oz Pt. Averages exclude first and last partial years of production.

Slide 67: Zafrañal Cu-Au Porphyry (80%)

1. Financial summary based on At-Sanction Economic Assessment using: US\$3.50/lb Cu and US\$1,400/oz Au. Detailed Engineering, Permitting and Project Set-up costs not included. All calendar dates and timeline are preliminary potential estimates.
2. EBITDA and C1 cash cost are non-GAAP financial measures. See "Non-GAAP Financial Measures" slides.
3. First five full years of production.

Slide 68: San Nicolás Cu-Zn (Ag-Au) VHMS (100%)

1. Financial summary based on At-Sanction Economic Assessment using: US\$3.50/lb Cu, US\$1.15/lb Zn, US\$1,400/oz Au and US\$18/oz Ag. Go-forward costs of Prefeasibility, Detailed Engineering, Permitting and Project Set-up costs not included. All calendar dates and timeline are preliminary potential estimates.
2. EBITDA and C1 cash cost are non-GAAP financial measures. See "Non-GAAP Financial Measures" slides.
3. First five full years of production (Year 2 – Year 6).

Slide 69: Medium Term Development Options

1. QB Hypogene Reserves: 1,432Mt at 0.51% Cu, 0.021% Mo, 1.4 g/t Ag.
2. C1 cash cost is a non-GAAP financial measure. See "Non-GAAP Financial Measures" slides. C1 cash cost are shown net of by-product credits. All averages exclude first and last partial years of production.
3. QB Hypogene Mineral Resources (exclusive of reserves) from Teck's 2020 AIF. Estimates were prepared assuming metal prices of US\$3.00/lb Cu and US\$ 9.4/lb Mo, pit slope angles of 30 – 42 degrees and variable metallurgical recoveries.
4. QB Hypogene Mineral Resources are constrained by a pit shell developed using Whittle™ software considering similar assumptions as for Reserves. Resources are reported at Net Smelter Return cut-off of US\$ 8.35/t.
5. Galore Creek Production potential was calculated with price assumptions: US\$3.50/lb Cu; US\$1,400/oz Au; US\$18/oz Ag.
6. Galore Creek Mineral Resources are estimated using metal price assumptions of US\$3.00/lb copper, US\$1,200/oz gold and US\$20/oz silver using a US\$8.84/t Net Smelter Return cut-off.
7. Galore Creek Mineral Resources are reported within a constraining pit shell developed using Whittle™ software. Inputs to the pit optimization include the following assumptions: metal prices; pit slope angles of 36.3 – 51.9 degrees; variable metallurgical recoveries averaging 90.6% for copper, 73.1% for gold and 64.5% for silver.
8. Galore Creek Mineral Resources have been estimated using a US\$8.84/t Net Smelter Return cut-off, which are based on cost estimates from a 2011 Prefeasibility Study. Assumptions consider that major portions of the Galore Creek Project are amenable for open pit extraction.

Slide 70: Right Assets: Portfolio of Copper Growth Options - Multiple high quality copper options

1. Financials and CuEq calculated with price assumptions: US\$3.50/lb Cu; US\$1.15/lb Zn; US\$6.90/lb Ni; US\$21/lb Co; US\$10/lb Mo; US\$1,400/oz Au; US\$18/oz Ag; US\$1,300/oz Pd; US\$1,200/oz Pt. C1 cash costs are shown net of by-product credits. All averages exclude first and last partial years of production.
2. Financial summary based on At-Sanction Economic Assessment. Go-forward costs of Prefeasibility, Detailed Engineering, Permitting and Project Set-up costs not included.
3. Various paths to expansion including 50% increase, doubling and tripling of throughput.

RACE21™ Technology and Innovation Program

*Please see the video of the RACE21™
presentation at our Investor & Analyst
Day [here](#), starting at ~1:28*



RACE - Teck's Path to Transformation

A journey kickstarted in 2019 to unlock the potential of technology and our people



Renew

the technology and data infrastructure

Automate

operations

Connect

systems across the value chain

Empower

Teck's workforce through digital

... to reduce operating cost and significantly improve safety, sustainability, and productivity

Strengthen Existing High-Quality Assets Through RACE21™



Focus

Transformational **safety** impact

Step-change impact to operational **efficiency**

Increased **productivity** through technology and innovation

Increased **margins**

Examples

Advanced data analytics and artificial intelligence to reduce risk of heavy vehicle / light vehicle interactions

Increased copper throughput by ~7% and recovery by ~2% at Highland Valley Copper

Record haul truck productivities at our coal sites, up 0.5% versus same period last year

Improved zinc feed margins by \$5 per tonne processed at our Trail Operations

RACE21™ is driving operational improvements and transforming our business through technology and innovation

Base Metals Business Units – Copper and Zinc

Teck



Significant Base Metals Growth

Expanding our high-quality Base Metals business

~100%

**Near-term copper
production growth¹**

>850kt

**Per year copper
equivalent
production by 2023²**

>50%

**Gross Profit Margin
before Depreciation
& Amortization³**

\$3.8B

**Illustrative EBITDA
from Base Metals
with QB2^{4,5}**

- High-quality operating assets with strong margins
- Substantial near-term growth from QB2
- Operational excellence underpins cost competitiveness
- Driving improved performance with RACE21™

Building on our foundation of quality assets and operating discipline

Significant Base Metals Growth

Teck's Base Metals business rivals leading copper peers

Consolidated Copper Equivalent Production ¹ (kt CuEq)

■ Copper ■ Zinc (CuEq) ■ Other (CuEq)

Teck

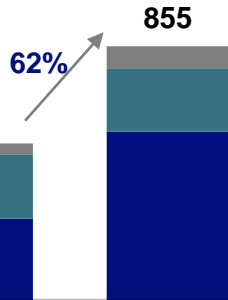

First Quantum

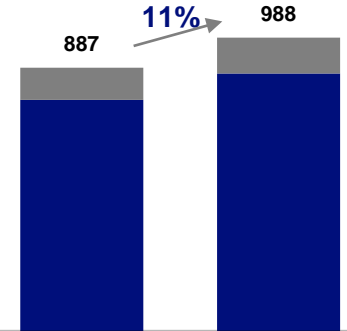

Antofagasta

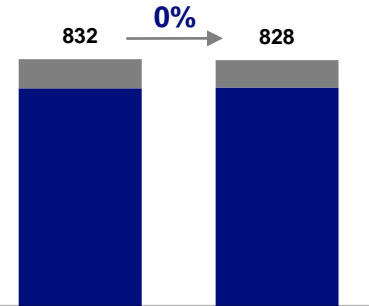

	Teck 2020A	Teck 2023E	First Quantum 2020A	First Quantum 2023E	Antofagasta 2020A	Antofagasta 2023E
Reserves ²	34.1	36.2	21.6	21.6	21.6	21.6
M&I Res. ²	56.8	10.8	58.1	58.1	58.1	58.1
Inferred Res. ² (CuEq Mt)	50.3	13.1	57.9	57.9	57.9	57.9
Operating Jurisdictions	Canada, USA, Chile, Peru		Zambia, Mauritania, Panama, Spain, Turkey, Finland		Chile	

Reserves²
M&I Res.²
Inferred Res.²
(CuEq Mt)

Operating Jurisdictions

Canada, USA,
Chile, Peru

Zambia, Mauritania,
Panama, Spain, Turkey,
Finland

Chile

Significant Base Metals Growth

Teck's Base Metals business rivals leading copper peers

Consolidated Copper Equivalent Production ¹ (kt CuEq)

■ Copper ■ Zinc (CuEq) ■ Other (CuEq) ■ Attributable (CuEq)

Teck

First Quantum

Antofagasta

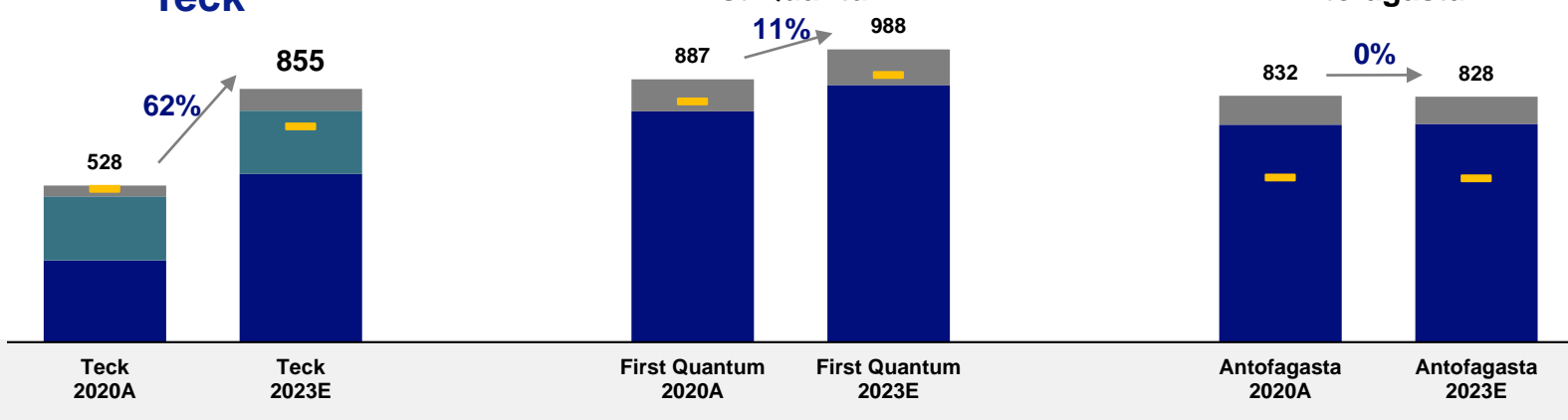

C1 Cost²
(US\$/lb Cu)

\$1.28

\$1.16

\$1.21

\$1.33

\$1.14

\$1.14

Enterprise
Value³ (C\$B)

\$29.9

\$27.3

Industry Leading Copper Growth

Building on our foundation of quality assets and operating discipline

Quality assets with strong margins

- Antamina, Highland Valley and Carmen de Andacollo provide a stable, low-cost operating foundation
- QB2 has low strip ratio and AISC³ in second quartile
- Continuous improvement is core to operating philosophy

Significant near-term growth and options

- QB2 first production in the second half of 2022
- Teck is positioned to realize value from a robust pipeline of copper projects
- Multiple high-quality near-term (San Nicolas and Zafranal), medium-term (QB3 and Galore Creek) and mine life extension (HVC and Antamina) options

Gross Profit Margin Before Depreciation & Amortization from Operations Consistently ~45-55%¹

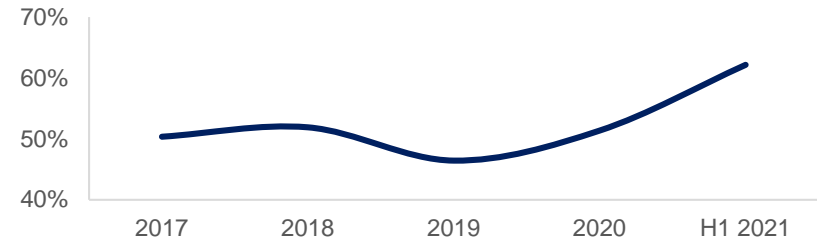

Teck Consolidated Copper Production² (kt Cu)

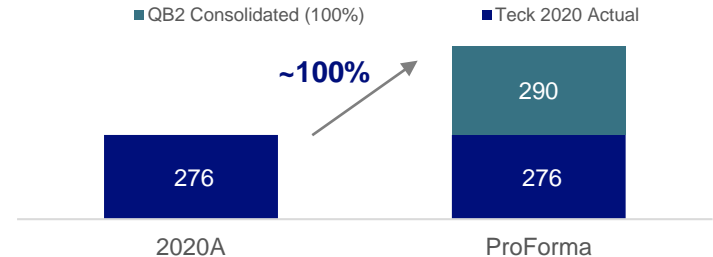

Continue to prudently advance the growth portfolio to increase the value and certainty of options

World Class Zinc Business

Large scale, low-cost integrated business

Quality assets with strong margins

- Red Dog is a first quartile cash cost operation
- Trail produces refined zinc, lead, and other products with clean, renewable power and strong recycling capabilities

Integrated business model

- Unique position as largest net zinc miner
- Exposure to price increases and market changes

Attractive development opportunities

- Significant potential mine life extension in Red Dog district, with large, high grade mineralized system
- Several of the top next generation zinc assets

Gross Profit Margin before Depreciation & Amortization from Mining Operations Consistently >50%¹



Teck Has Several Large Undeveloped Zinc Assets²

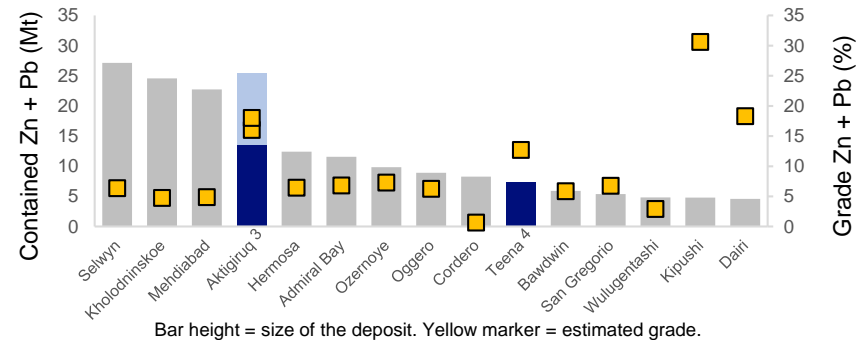

Maximizing cash flows from quality assets

RACE21™ – Processing Analytics Journey

Significant improvements realized within our processing plants

Red Dog Operations

- Advanced grinding control has realized a ~9% increase in production rates¹

Highland Valley Copper

- Deployed real-time optimization models have realized a ~7% increase in copper production²

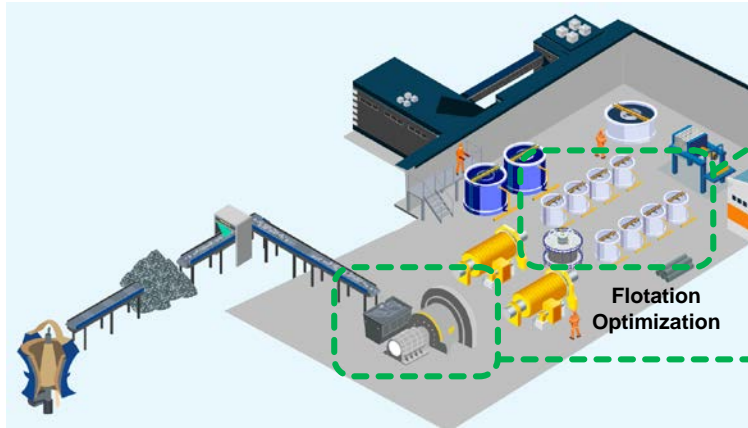

Highland Valley Copper IPM Flotation Recommendations

Line 1	Update	Old Rec	Current Value	New Rec	Line 2	Update	Old Rec	Current Value	New Rec	Line 3	Update	Old Rec	Current Value	New Rec
Apr 20 2021 8:52PM					Apr 21 2021 8:24AM					Apr 21 2021 8:24AM				
Poly Dosage R1 Ratio		60	67		Poly Dosage R1 Ratio		62	63	63	Poly Dosage R1 Ratio		64	65	65
Poly Dosage R2 Ratio		10	23		Poly Dosage R2 Ratio		11	11	11	Poly Dosage R2 Ratio		10	9	9
Poly Dosage S1 Ratio		16	5		Poly Dosage S1 Ratio		15	14	14	Poly Dosage S1 Ratio		15	14	14
Poly Dosage S3 Ratio		13	5		Poly Dosage S3 Ratio		12	12	12	Poly Dosage S3 Ratio		12	12	12
L1 R1 Froth Velocity		9.5	9.5		L2 R1 Froth Velocity		9.5	9.5	9.5	L3 R1 Froth Velocity		9.5	9.5	9.5
L1 R2 Froth Velocity		5.0	5.0		L2 R2 Froth Velocity		4.0	4.0	4.0	L3 R2 Froth Velocity		5.2	5.2	5.2
L1 R3 Froth Velocity		4.7	4.7		L2 R3 Froth Velocity		4.7	4.7	4.7	L3 R3 Froth Velocity		5.7	5.7	5.7
L1 S1 Froth Velocity		3.4	3.4		L2 S1 Froth Velocity		2.8	2.8	2.8	L3 S1 Froth Velocity		2.9	2.9	2.9
L1 S2 Froth Velocity		4.9	4.9		L2 S2 Froth Velocity		3.2	3.2	3.2	L3 S2 Froth Velocity		2.7	2.7	2.7
L1 S3 Froth Velocity		4.2	4.2		L2 S3 Froth Velocity		3.0	3.0	3.0	L3 S3 Froth Velocity		2.4	2.4	2.4
L1 S4 Froth Velocity		2.5	2.5		L2 S4 Froth Velocity		3.3	3.4	3.4	L3 S4 Froth Velocity		3.5	3.5	3.5
L1 Feed Density		40.0	40.0		L2 Feed Density		39.6	39.3	39.3	L3 Feed Density		38.9	38.9	38.9

General	Update	Old Rec	Current Value	New Rec
Apr 21 2021 8:24AM				
Poly addition (g/T)		16.0	11.0	16.5
PAX Dosage		4.0	5.0	4.0
SIX Dosage		2.5	2.5	2.5
Pine Oil Dosage		5.6	5.3	5.3
Distributor Box pH		9.5	10.0	9.5

Lines 123	Update	Old Rec	Current Value	New Rec
Apr 21 2021 8:24AM				
L123 Density		39.3	39.3	39.1

Update All Recommendations

OSA Tis Grade

Line 1 Adjust Setpoints as Necessary 0.000

Line 2 Model OK 0.030

Line 3 Model OK 0.032

General Model OK

Red Dog Grinding Circuit

SAG1 Targets/Limits

LL	PV	HL
Amps 235	248	275
BP 640	613	665
TPH SP 180		
TPH PV 188		

SAG2 Targets/Limits

LL	PV	HL
Amps 235	224	275
BP 470	455	495
TPH SP 190		
TPH PV 183		

SAG3 Targets/Limits

LL	PV	HL
Amps 235	235	275
BP 640	632	660
TPH SP 180		
TPH PV 181		

SAG OCS Total TPH Control Limits

Total TPH Input	TPH Zn	TPH SiO2
640	85.4	
Total TPH SP 540		
Total TPH PV 527		
Total TPH LIMIT 190	190	190

Feed rate (tph)

Max	SP	PV
190	190	160
SP 180	190	160
PV 188	187	151
SP Change 0.0	0.0	0.0

Speed (rpm)

Max	SP	PV
240	240	240
SP 150	150	209
PV 152	151	209
SP Change 150	150	150

Density (%)

Target	SP	PV
70	68	68
SP 70	68	68
PV 70	68	68

Feed Water (gpm)

SP	PV
100	100
SP 100	100
PV 100	100

Optimizer

SAG1 SAG2 SAG3

B.Press HL 665 495 660

PV 613 455 632

LL 640 470 640

Speed HL 165 165 224

Control ON OFF

Dynamic Constraint (%)

SAG1 SAG2 SAG3

Feedrate 100 100 100

Speed 0 0 80

Amps 0 0 1

B.Press 0 0 0

Significant Base Metals Cash Flow

Expanding our high-quality Base Metals business

- High quality, growing copper business
- World class zinc business
- Focus on operating discipline
- Significant improvements driven by RACE21™



Building on our foundation of quality assets and operating discipline

Operations Improvement and Cash Flow Focus in Copper

Productivity & Cost Management

- Focus on reliability and maintenance and cross site sharing
- RACE21™ and continuous improvement pipeline driving benefits across sites – a key driver of margins
- Cost reductions embedded in plans

Focused Investment Priorities

- Key water, tailings and regulatory projects drive sustaining capital requirements
- Near-term higher sustaining spending from tailings facility costs at Antamina
- Long-term sustaining capex (2024+) in copper expected at \$125 million, excluding QB2 and life extension projects

Copper Unit Costs

Unit Costs¹ in 2020

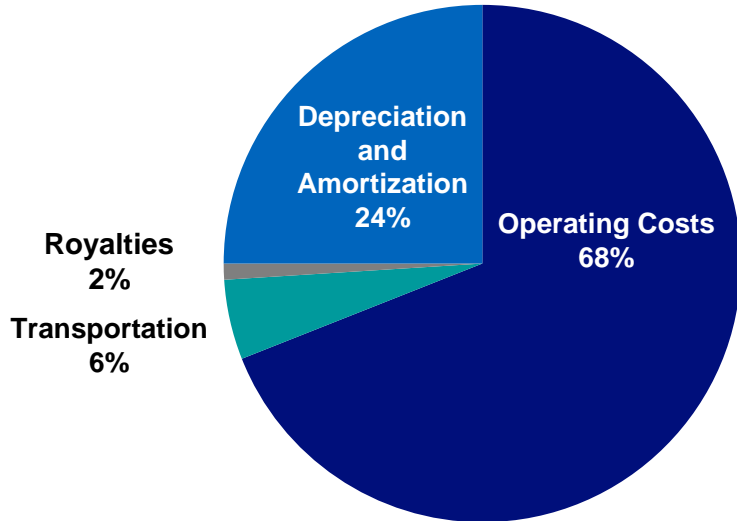

Operating Cost¹ Breakdown in 2020

Labour	30%
Contractors and Consultants	11%
Operating Supplies	16%
Repairs and Maintenance Parts	16%
Energy	20%
Other	6%
Total	100%

Operations Improvement and Cash Flow Focus in Zinc

Productivity

- Focus on asset management and cross site sharing
- RACE21™ and continuous improvement pipeline driving benefits across sites – a key driver of margins
- Cost reductions embedded in plans

Focused Investment Priorities

- Key water, tailings and regulatory projects drive sustaining capital requirements
- Near term higher sustaining spending from tailings related projects at Red Dog and air quality and asset renewal at Trail Operations
- Long-term sustaining capex (2024+) in zinc expected at \$150 million, excluding life extension projects

Zinc Unit Costs

Unit Costs¹ in 2020

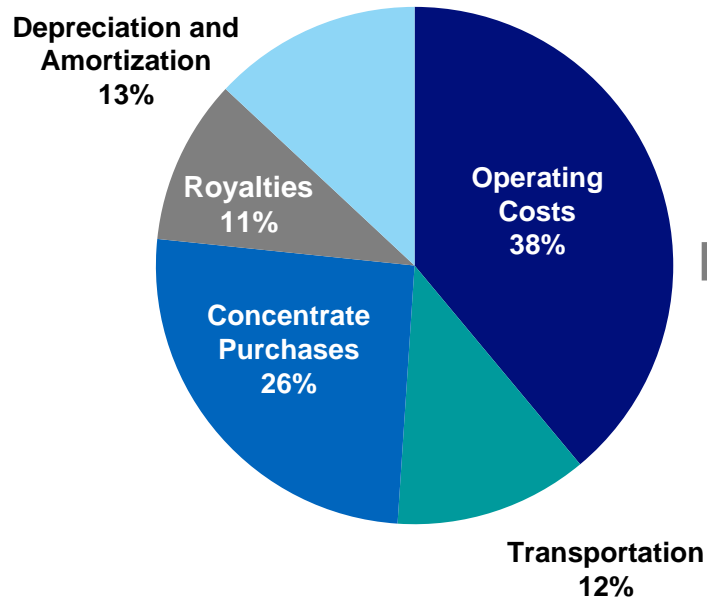

Operating Cost¹ Breakdown in 2020

Labour	35%
Contractors and Consultants	10%
Operating Supplies	11%
Repairs and Maintenance Parts	9%
Energy	18%
Other	17%
Total	100%

Red Dog Sales Seasonality

- Operates 12 months
- Ships ~ 4 months
- Shipments to inventory in Canada and Europe; Direct sales to Asia
- ~65% of zinc sales in second half of year
- ~100% of lead sales in second half of year
- Sales seasonality causes net cash unit cost seasonality

Zinc Sales¹ (%)

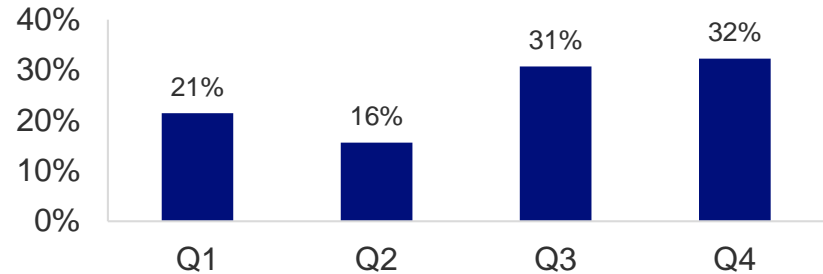

Lead Sales¹ (%)

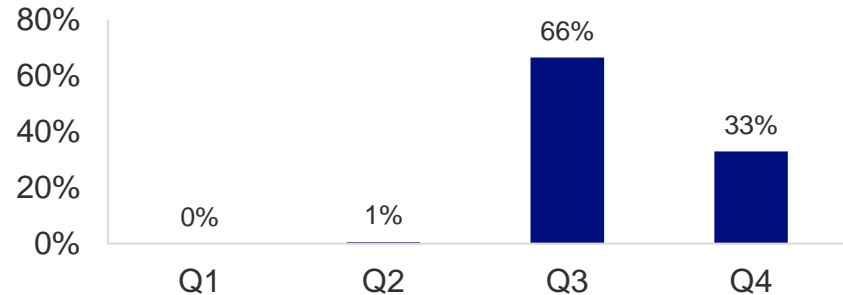

Red Dog Net Cash Unit Cost Seasonality

Five-Year Average Red Dog Net Cash Unit Costs¹ (US\$/lb)

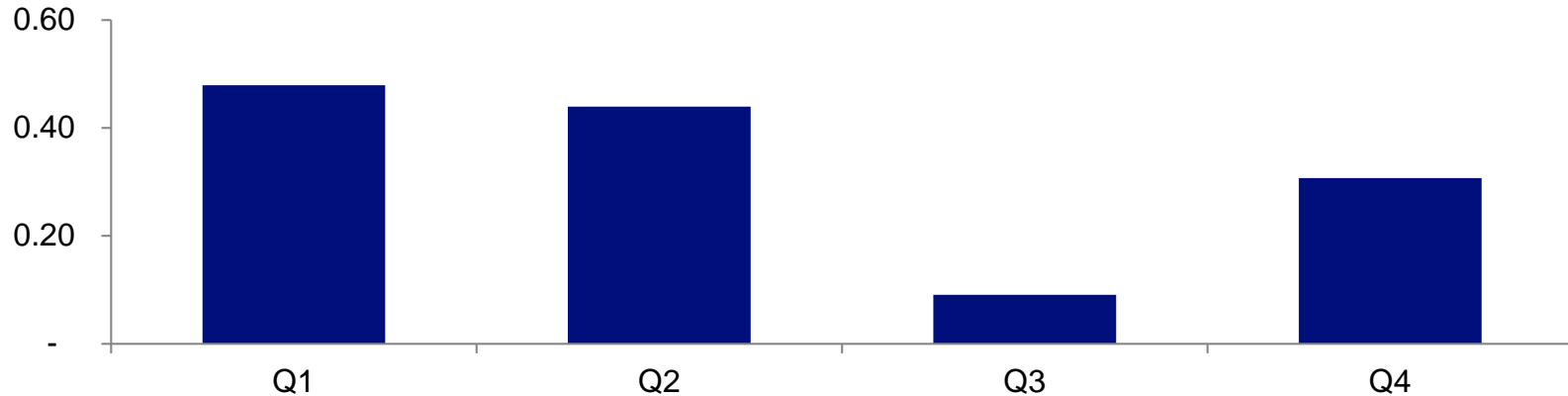

- Seasonality of Red Dog unit costs largely due to lead sales during the shipping season
- Higher net cash unit costs expected in 2021 compared to 2020 due primarily to lower production volumes in 2020, as well as lower contribution from silver by-products

Red Dog in Bottom Quartile of Zinc Cost Curves

Higher zinc prices illustrate continuing tight market

Total Cash + Capex Cost Curve 2021¹ (US¢/lb)

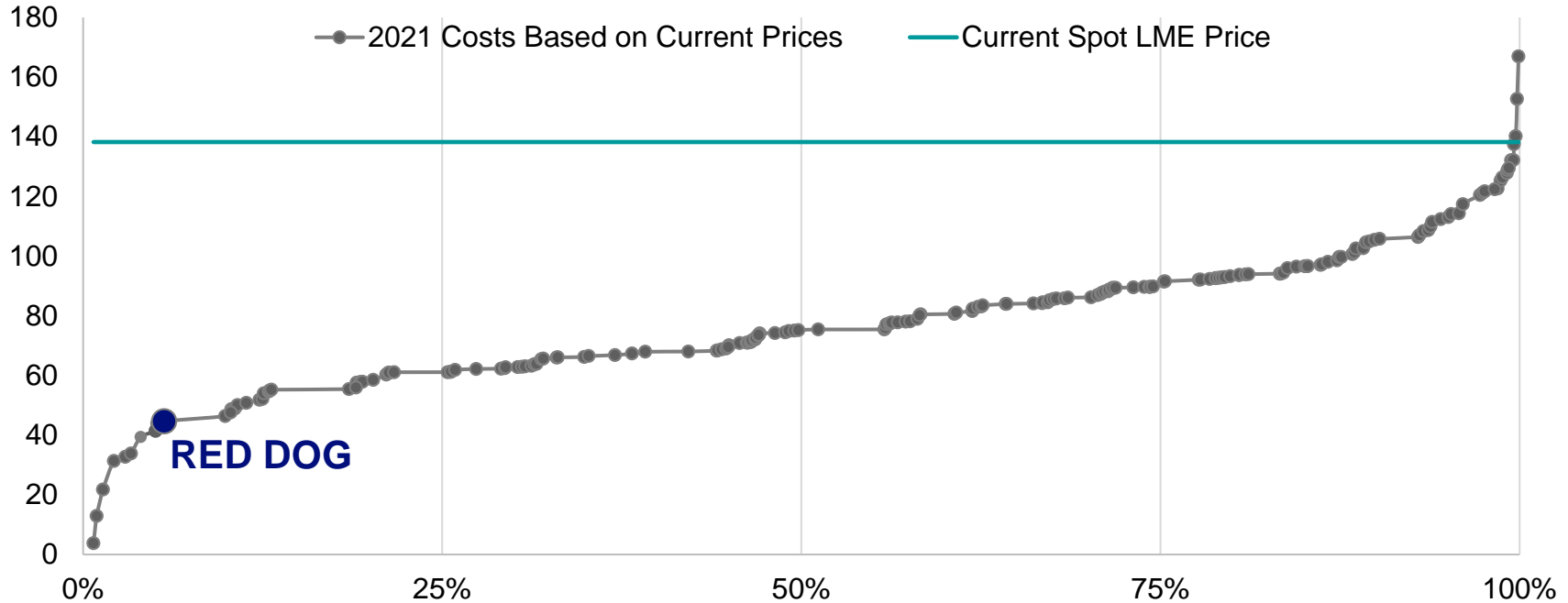

Red Dog Extension Project

Long Life Asset

- Aktigiruaq exploration target of 80-150 Mt @ 16-18% Zn + Pb¹
- Anarraaq Inferred Resource²: 19.4 Mt @ 14.4% Zn, 4.2% Pb

Quality Project

- Premier zinc district
- Significant mineralized system
- High grade

Stable Jurisdiction

- Operating history
- ~12 km from Red Dog operations



Endnotes: Base Metals Business Units

Slide 76: Significant Base Metals Growth - Expanding our high-quality Base Metals business

1. Source: Wood Mackenzie base case copper production dataset. Consolidated production estimate was derived based on accounting standards for consolidation. Copper production growth estimate uses 2020 actual production and Wood Mackenzie data for 2023.
2. Production for 2023 is sourced from Wood Mackenzie asset models and is shown on a consolidated reporting basis. Copper equivalent production includes copper, zinc, molybdenum, lead and gold, considering production from Teck's Copper and Zinc mining assets only. Copper equivalent production is calculated using the following prices: US\$3.50/lb Cu, US\$1.15/lb Zn, US\$0.90/lb Pb, US\$10.50/lb Mo, US\$1.650/oz Au.
3. Mining operations only, and therefore excludes Trail. Calculated as Gross Profit Before Depreciation & Amortization divided by reported Revenue, sourced from Teck's public disclosures for the period of 2017 through the first half of 2021. Gross Profit Before Depreciation & Amortization Margin from Mining Operations is a non-GAAP financial measure.
4. Illustrative Base Metals EBITDA is H1 2021 Adjusted EBITDA for our Copper and Zinc Business Units annualized and price adjusted assuming prices of US\$3.50/lb Cu and US\$1.15/lb Zn. All other commodity prices are at H1 2021 actual average prices with a Canadian / U.S. dollar exchange rate of \$1.25. The sensitivity of our EBITDA to changes in commodity prices are: US\$0.01/lb change in copper price = C\$7 million EBITDA; US\$ 0.01/lb change in zinc price = C\$12 million EBITDA. EBITDA and Adjusted EBITDA are non-GAAP financial measures. See "Non-GAAP Financial Measures" slides.
5. QB2 EBITDA assumes a C1 cash cost of US\$1.28/lb, a Canadian/U.S. dollar exchange rate of 1.25 and annual copper sales of 290,000 tonnes. EBITDA is a non-GAAP financial measure. See "Non-GAAP Financial Measures" slides.

Slide 77: Significant Base Metals Growth - Teck's Base Metals business rivals leading copper peers

1. Production for 2020 reflects actuals sourced from company disclosures. Production for 2023 is sourced from Wood Mackenzie asset models, considering assets included in Wood Mackenzie's base case for each company. Production is shown on a consolidated reporting basis. Copper equivalent production for 2020 is calculated using annual average prices of: US\$2.83/lb Cu, US\$1.05/lb Zn, US\$0.85/lb Pb, US\$8.68/lb Mo, US\$1,779/oz Au, US\$20.70/oz Ag, US\$6.43/lb Ni. Copper equivalent production for 2023 is calculated using the following prices: US\$3.50/lb Cu, US\$1.15/lb Zn, US\$0.90/lb Pb, US\$10.50/lb Mo, US\$1.650/oz Au, US\$22.50/oz Ag, US\$6.90/lb Ni.
2. Teck's contained equivalent copper metal at 100% basis for all Copper and Zinc assets. See Teck's 2020 AIF for further information, including the grade and quantity of reserves and resources for these assets and the grade of the other metals used to determine the copper equivalent. Contained equivalent copper metal for peers are sourced from SNL Financial – S&P Global Market Intelligence. Copper equivalent is calculated using prices of: US\$3.50/lb Cu; US\$1.15/lb Zn; US\$6.90/lb Ni; US\$21/lb Co; US\$10/lb Mo; US\$1,400/oz Au; US\$18/oz Ag; US\$1,300/oz Pd; US\$1,200/oz Pt.

Slide 78: Significant Base Metals Growth - Teck's Base Metals business rivals leading copper peers

1. Production for 2020 reflects actuals sourced from company disclosures. Production for 2023 is sourced from Wood Mackenzie asset models, considering assets included in Wood Mackenzie's base case for each company. Production is shown on a consolidated reporting basis, except where noted as attributable for ownership. Copper equivalent production for 2020 is calculated using annual average prices of: US\$2.83/lb Cu, US\$1.05/lb Zn, US\$0.85/lb Pb, US\$8.68/lb Mo, US\$1,779/oz Au, US\$20.70/oz Ag, US\$6.43/lb Ni. Copper equivalent production for 2023 is calculated using the following prices: US\$3.50/lb Cu, US\$1.15/lb Zn, US\$0.90/lb Pb, US\$10.50/lb Mo, US\$22.50/oz Ag, US\$6.90/lb Ni.
2. 2020 C1 cash cost data is sourced from company disclosures and are for copper operations only. Expected 2023 C1 cash cost data is sourced from S&P Global Market Intelligence (formerly SNL Metals & Mining) cost curve database considering primary copper mines and total cash costs on a by-product basis for Teck and peers, and weighted on a consolidated production basis.
3. Enterprise Value, or Total Enterprise Value is as of market close on August 30, 2021 and is sourced from S&P Capital IQ.

Slide 79: Industry Leading Copper Growth

1. Calculated as reported Gross Profit before D&A divided by reported Revenue, sourced from Teck's public disclosures. Margin data from 2017-2020 are for the full year, while margin data for 2021 reflects available results through the first half of 2021 only. Gross Profit Before Depreciation & Amortization Margin from Operations is a non-GAAP financial measure.
2. We include 100% of production from our Quebrada Blanca and Carmen de Andacollo mines in our production and sales volumes, even though we do not own 100% of these operations, because we fully consolidate their results in our financial statements. We include 22.5% of production from Antamina, representing our proportionate ownership interest in the operation. QB2 is on a consolidated basis and is based on the QB2 Sanction Case first five full years of copper production.
3. All-in sustaining costs (AISC) are net cash unit costs (also known as C1 cash costs) plus sustaining capital expenditures. Net cash unit costs are calculated after cash margin by-product credits assuming US\$10.00/lb molybdenum and US\$18.00/oz silver. Net cash unit costs for QB2 include stripping costs during operations. AISC, Net cash unit cost and cash margins for by-products are non-GAAP financial measures which do not have a standardized meanings prescribed by International Financial Reporting Standards (IFRS) or Generally Accepted Accounting Principles in the United States. These measures may differ from those used by other issuers and may not be comparable to such measures as reported by others. These measures are meant to provide further information about our financial expectations to investors. These measures should not be considered in isolation or used in substitute for other measures of performance prepared in accordance with IFRS. For more information on our calculation of non-GAAP financial measures please see our Management's Discussion and Analysis for the year ended December 31, 2018, which can be found under our profile on SEDAR at www.sedar.com.

Endnotes: Base Metals Business Units

Slide 80: World Class Zinc Business

1. Mining operations only, and therefore excludes Trail. Calculated as Gross Profit before D&A divided by reported Revenue, sourced from Teck's public disclosures. Margin data from 2017-2020 are for the full year, while margin data for 2021 reflects available results through the first half of 2021 only. Gross Profit Margin Before Depreciation & Amortization from Mining Operations is a non-GAAP financial measure.
2. Sources: S&P Global Market Intelligence, SNL Metals & Mining Database, Teck Public Disclosures.
3. 80-150 Mt @ 16-18% Zn + Pb. Aktigiruiq is an exploration target, not a resource. Refer to press release of September 18, 2017, available on SEDAR. Potential quantity and grade of this exploration target is conceptual in nature. There has been insufficient exploration to define a mineral resource and it is uncertain if further exploration will result in the target being delineated as a mineral resource.
4. Inferred resource of 58 Mt @ 11.1% Zn and 1.5% Pb, at a 6% Zn + Pb cut off, estimated in compliance with the Joint Ore Reserves Committee (JORC) Code. Excludes Myrtle.

Slide 81: RACE21™ – Processing Analytics Journey

1. Production rate increase is compared against a historical throughput baseline established for similar operating conditions when the tools were not in use.
2. Copper production increase is compared against a historical baseline established for similar operating conditions when the tools were not in use.

Slide 84: Copper Unit Costs

1. Copper unit costs are reported in US dollars per pound. Non-GAAP financial measures. See "Non-GAAP Financial Measures" slides.

Slide 86: Zinc Unit Costs

1. Zinc unit costs are reported in US dollars per pound. Non-GAAP financial measures. See "Non-GAAP Financial Measures" slides.

Slide 87: Red Dog Sales Seasonality

1. Average sales from 2016 to 2020.

Slide 88: Red Dog Net Cash Unit Cost Seasonality

1. Average quarterly net cash unit cost in 2016 to 2020, before royalties. Based on Teck 's reported financials. Net cash unit cost is a non-GAAP financial measure. See "Non-GAAP Financial Measures" slides.

Slide 89: Red Dog in Bottom Quartile of Zinc Cost Curves

1. Source: Data compiled by Teck from information from Wood Mackenzie, LME – Based on WM Forecast information and estimates for 2021 based on current short term average prices.

Slide 90: Red Dog Extension Project

1. Aktigiruiq is an exploration target, not a resource. Refer to press release of September 18, 2017, available on SEDAR. Potential quantity and grade of this exploration target is conceptual in nature. There has been insufficient exploration to define a mineral resource and it is uncertain if further exploration will result in the target being delineated as a mineral resource.
2. Based on Teck's 2020 Annual Information Form.

Copper Market

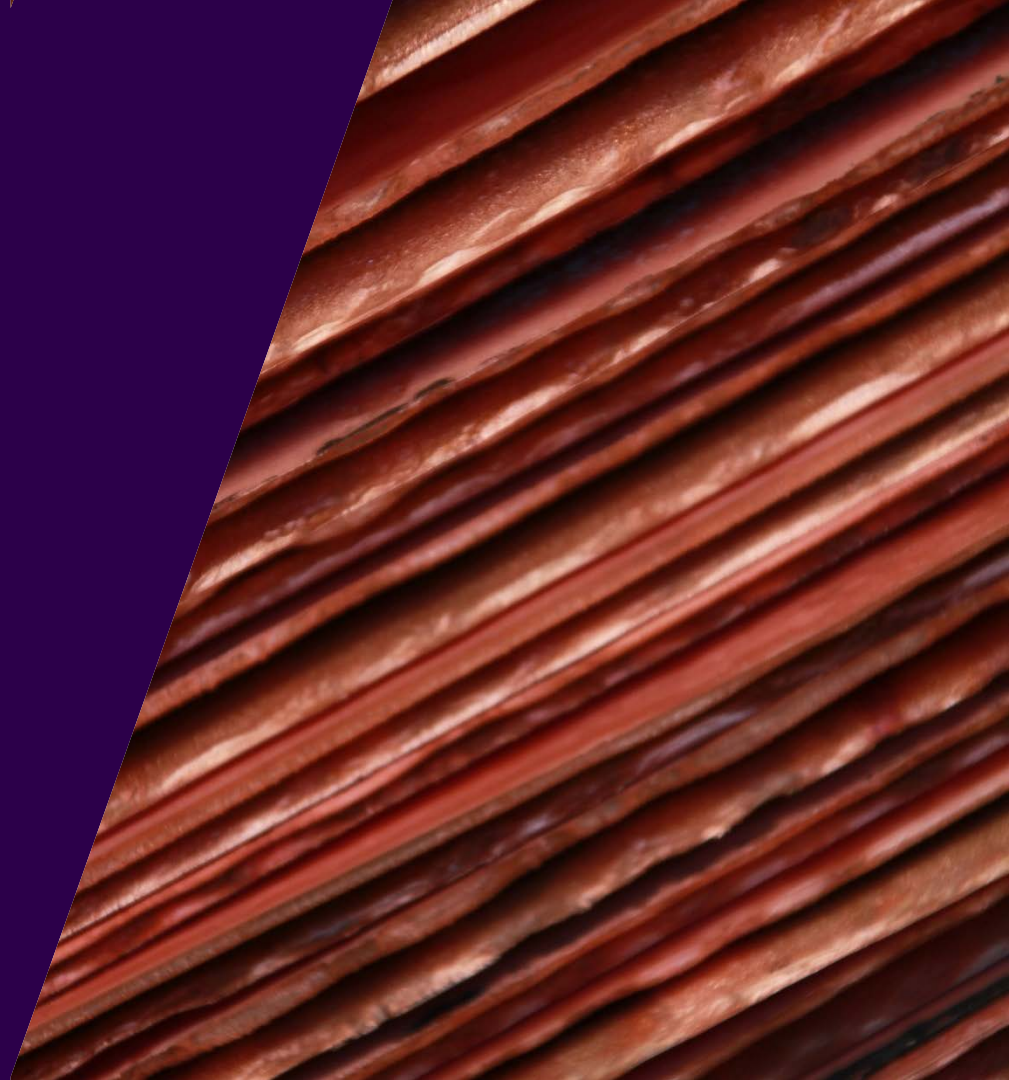

Copper Supply Needed for Electrification Targets

Supply committed pre-pandemic insufficient to meet growing demand

Supply response falling short

- >80% of the current committed mine projects were sanctioned prior to the pandemic
- Under an IEA 1.5 degree scenario, copper demand will grow by >12 Mt in the next 10 years
- In the last 20 years (China growth), copper mine production only grew 7 Mt
- Only 2.4 Mt is committed over the next five years

Demand accelerating in mid-term

- Automakers are raising five-year targets for EV fleets; up by 18% in the last six months
- Wind and solar driven by corporate agendas
- Current electric grid requires >10% increase to meet near term targets of 40% EV penetration

Copper Mine Growth¹ (kt)

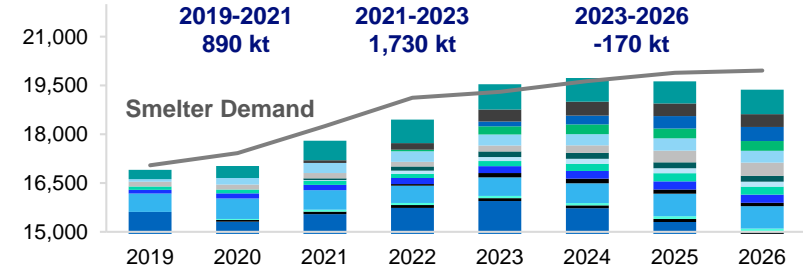

EV Change in Projected Growth

Last Six Months² (BEV + PHEV M units)

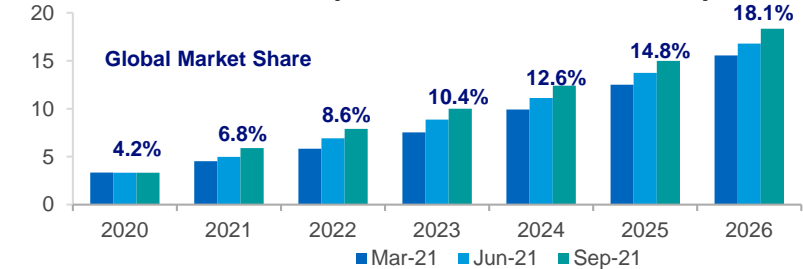

Teck well positioned for future copper demand growth

Copper Market

Scrap Availability Falls on lower Copper Price¹

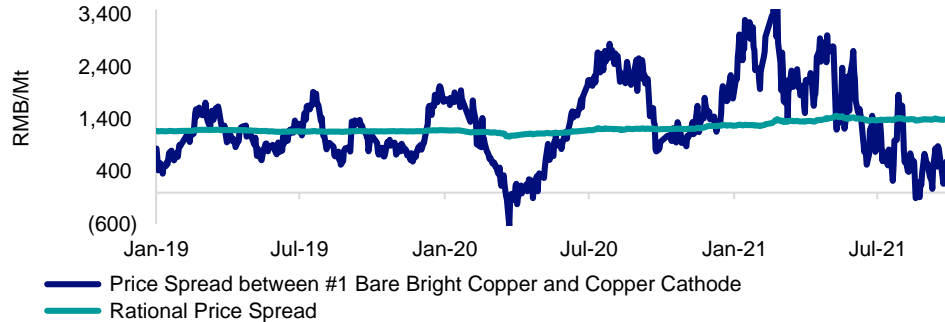

Copper Scrap is 18% of Supply and 20% of Total Demand²

Cathode Demand 23.6 Mt

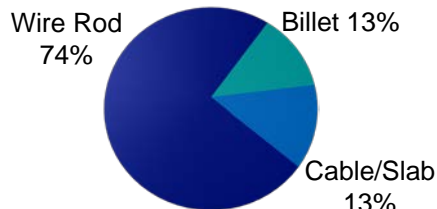

Copper Demand 29.6 Mt

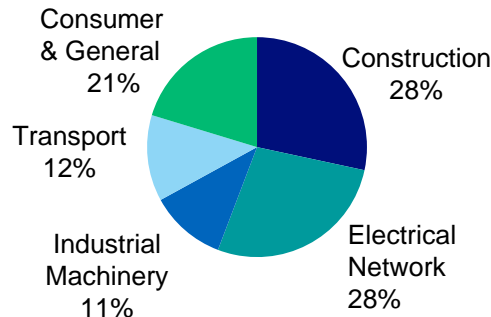

- Demand for raw materials and mine disruptions keep concentrate demand high
 - Mine production cuts over 1.4 Mt in 2020, disruptions low in Q2/Q3 2021 YTD ~0.6 Mt
 - Chinese/EU smelters face power restrictions
 - Spot TC/RC rise to mid-50's to low 60's
- LME price coming off record highs, but Chinese cathode premiums rise on falling stocks
- SHFE stocks fall, nearing 2009 lows
- Scrap availability falling on lower prices and reduced inventories from May 2021 highs
- Tight scrap market is pushing cathode premiums higher; Chinese cathode premiums US\$85-105 per tonne in Q3 2021

Global Copper Mine Production Increasing Slowly

Mine Production Set To Increase 2.2 Mt By 2024¹

Includes:

Mine	kmt
Kamoa – Kakula	535
PT – Freeport (vs 2019)	435
Quebrada Blanca 2	300
Quellaveco to 2024	275
Cobre Panama	252
China to 2024	345
All others (Spence, Chuqui UG, Escondida)	1,090
SXEW Reductions to 2024	(360)
Reductions & Closures	(654)

- Chinese mine production flat to 2024 on lack of resources
- Total probable projects: 900 kmt

Global Copper Mine Production² (kt contained)

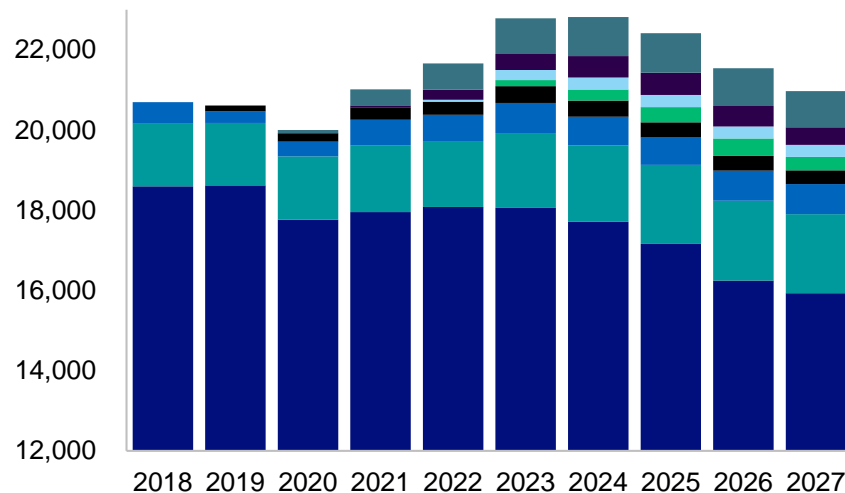

- Other
- PT Freeport
- Quellaveco
- Kamoa-Kakula
- China
- Cobre Panama
- Quebrada Blanca
- New Mines

Copper Disruptions Continue To Impact Mines

Smelters now facing power supply issues

TC/RCs Spot and Annual Falling¹ (US\$/lb)

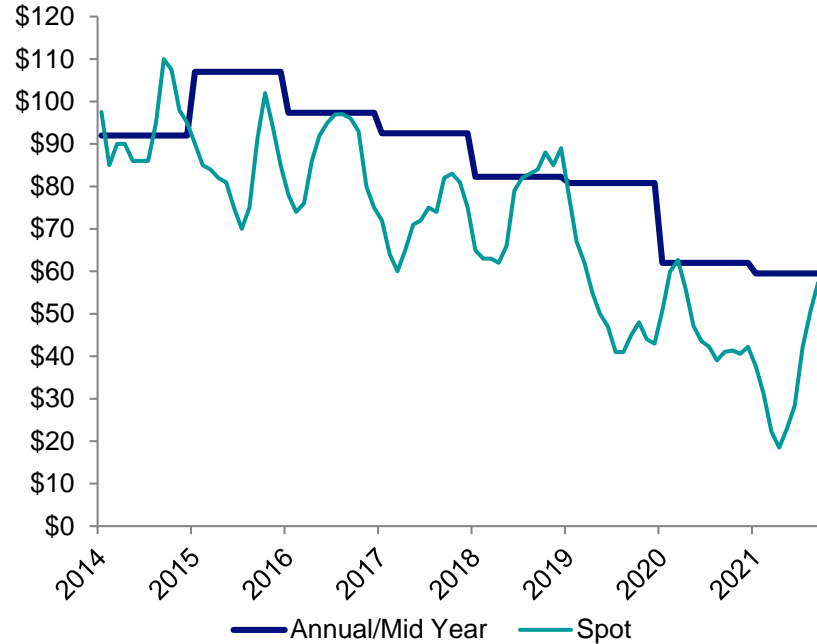

Disruptions (kt)²:

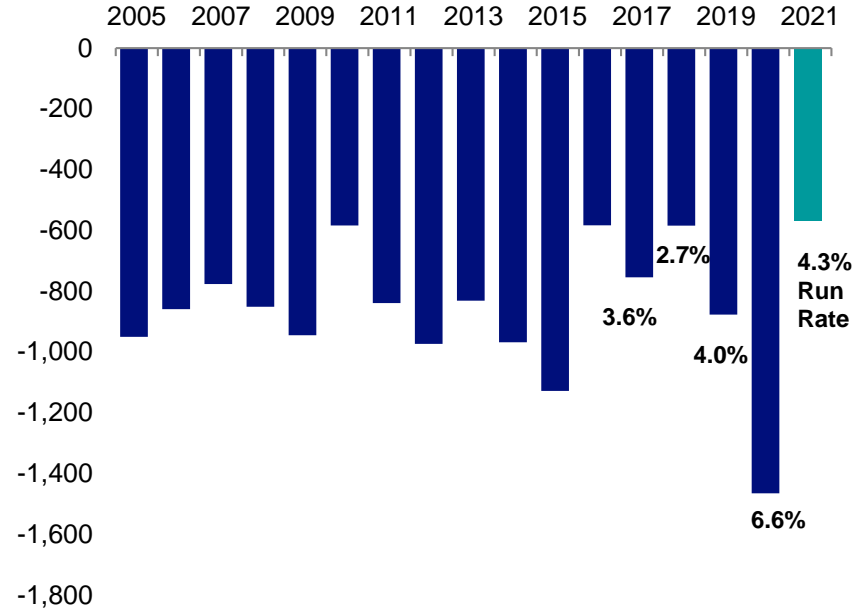

Rapid Growth in Chinese Copper Smelter Capacity

China added 3.2 Mt since 2019 (2.1 Mt still ramping up)

Chinese Copper Mine Growth¹ (kt)

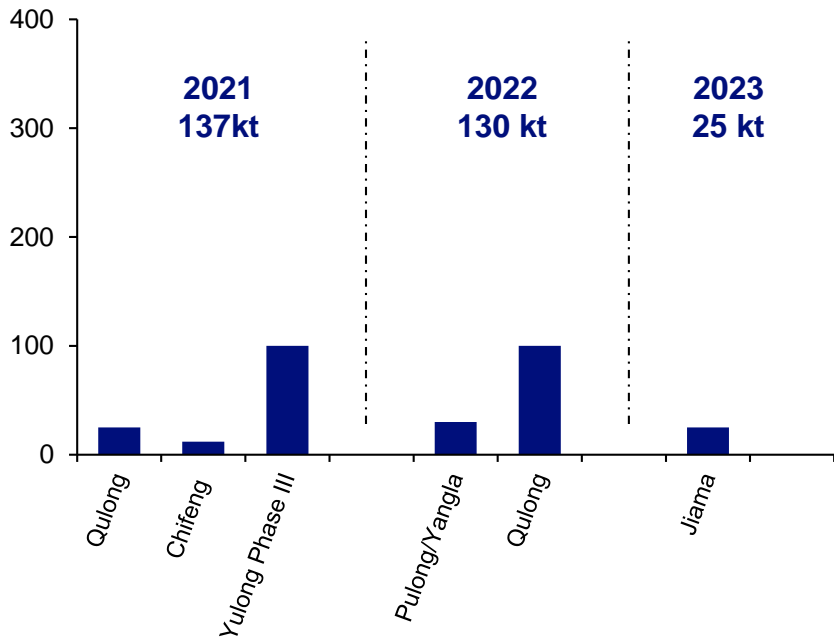

+2.1 Mt of New Smelting Capacity² (kt blister)

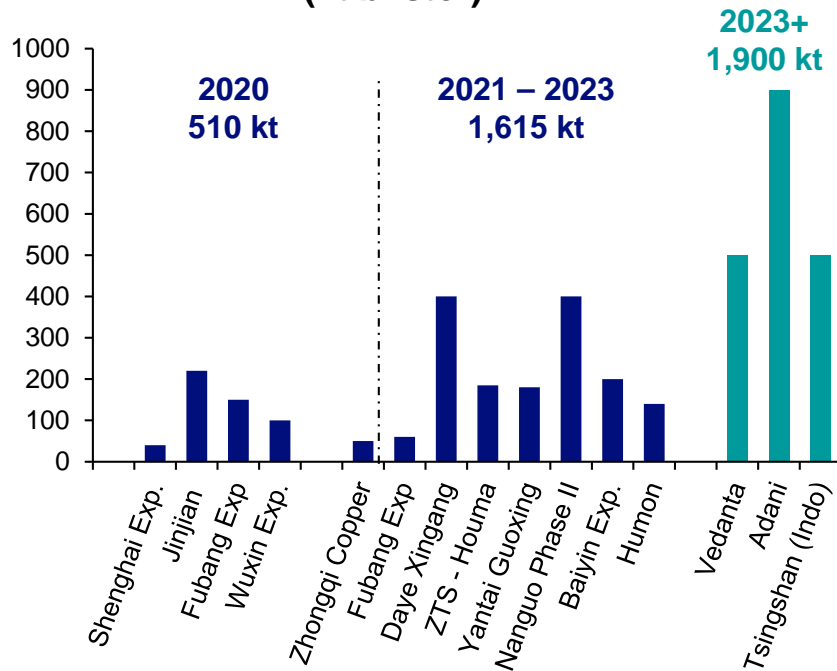

Copper Supply

Chinese imports shift to concentrates to feed smelter capacity increases

Chinese Scrap/Blister Imports Fall² (Copper content, kt)

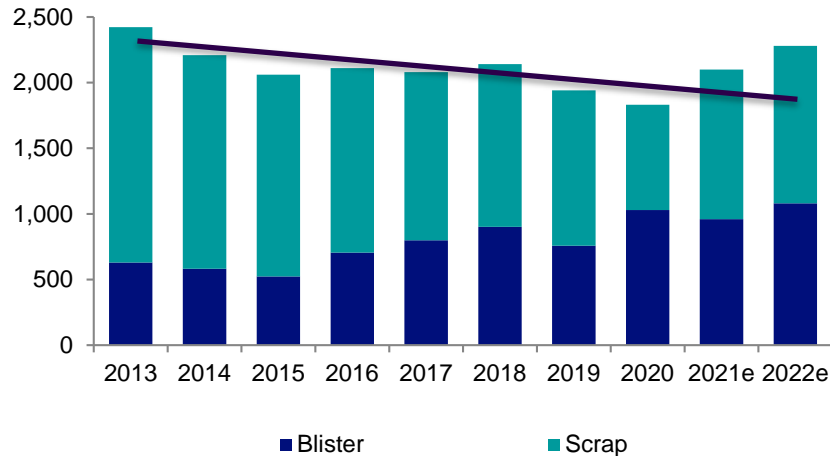

- Reclassified scrap/blister rising off the 2020 lows

Chinese Imports Shift to Concentrates³ (Copper content, kt)

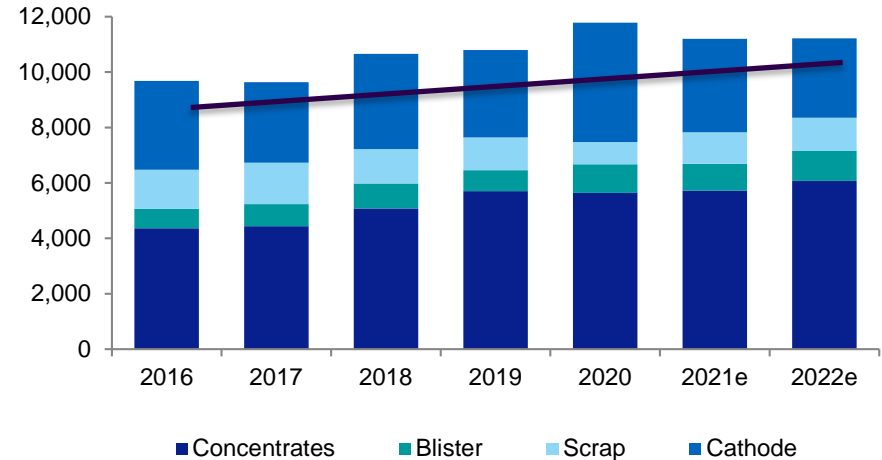

- Cathode imports drop in 2021, after tight concentrates and scrap market in 2020 saw record cathode imports
- Concentrates imports continue to rise on smelter demand

Copper Metal Stocks

Raw material shortages increase cathode demand

- Exchange stocks have fallen 310 kt since June, now equivalent to 4.6 days of global consumption
- SHFE stocks have decreased 110 kt and bonded stocks are down ~200 kt since the announced release of government stockpiles
- Visible global copper inventories have fallen 35% since June, all of it within China
- Rapidly rising copper prices pushed consumers to scrap markets in H1, consumers now returning to cathode market as scrap tightness increases
- Underlying demand remains supported despite cuts to power supplies, supply chain inventories low

Daily Copper Prices (US\$/mt) and Stocks¹ (kt)

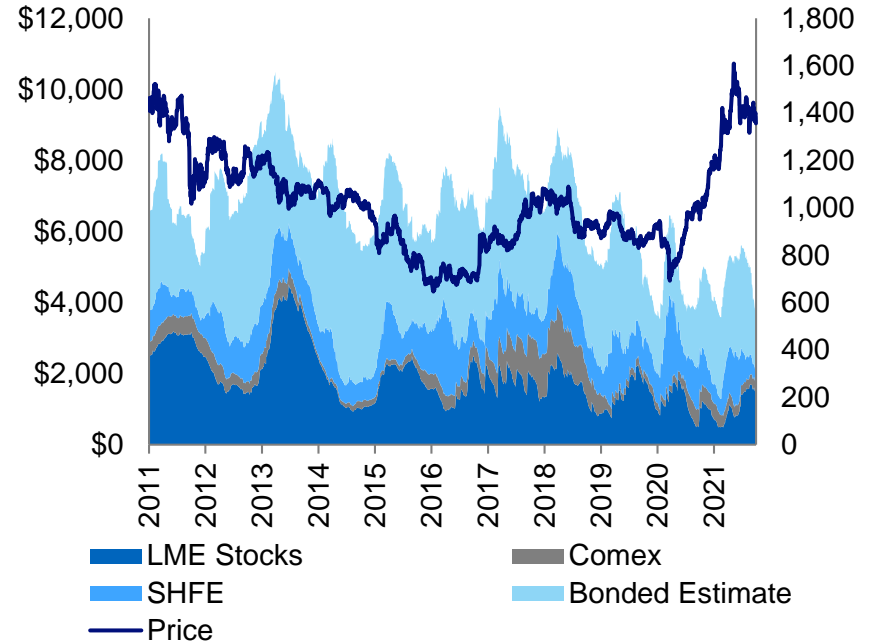

Endnotes: Copper Market

Slide 94: Copper Supply Needed for Electrification Targets

1. Copper concentrate supply and smelter demand 2019 – 2020 actuals and 2021 – 2026 forecasts, includes committed projects and projected 4% disruption allowance. Wood Mackenzie, CRU, Teck. As at September 30th, 2021.
2. Change in BEV/PHEV market share projections by global auto makers. Source: CRU.

Slide 95: Copper Market

1. Source: Shanghai Metal Market.
2. Source: Wood Mackenzie.

Slide 96: Global Copper Mine Production Increasing Slowly

1. Source: Data compiled by Teck based on information from Wood Mackenzie and Company Reports (average production first 10 years).
2. Source: Data compiled by Teck based on information from Wood Mackenzie and Teck's analysis of publicly available quarterly financial reports and other public disclosures of various entities.

Slide 97: Copper Disruptions Continue to Impact Mines

1. Source: Data compiled by Teck based on information from Wood Mackenzie, CRU, and Metal Bulletin.
2. Source: Data compiled by Teck based on information from Wood Mackenzie and Teck's analysis of publicly available quarterly financial reports and other public disclosures of various entities.

Slide 98: Rapid Growth in Chinese Copper Smelter Capacity

1. Includes mine projects with copper capacity >10 ktpa. Source: BGRIMM.
2. Source: BGRIMM, SMM, Teck.

Slide 99: Copper Supply

1. Source: Wood Mackenzie, GTIS, BGRIMM, SMM.
2. Source: Wood Mackenzie, GTIS, BGRIMM, SMM.

Slide 100: Copper Metal Stocks

1. Source: LME, Comex, SHFE, SMM.

Zinc Market

Teck



Zinc Outperforms Market Expectations

Chinese mine production continues to underperform expectations

Concentrate market remains tight through 2021

- Spot TCs relatively unchanged at historically low levels
- Energy shortages impacting Chinese smelters
- Chinese mine production growth limited going forward
- South American supply/logistics continue to struggle

Metal market better than projected

- Chinese mine supply did not deliver as analysts projected
- Galvanized steel demand strong globally, record high prices
- Auto production backlog likely to continue into 2022
- Ex-China infrastructure spending is now beginning
- Decarbonization trend will be steel intensive
- Galvanizing steel extends service life, reducing scrapping

China Zinc Concentrate Supply¹ (Kmt)

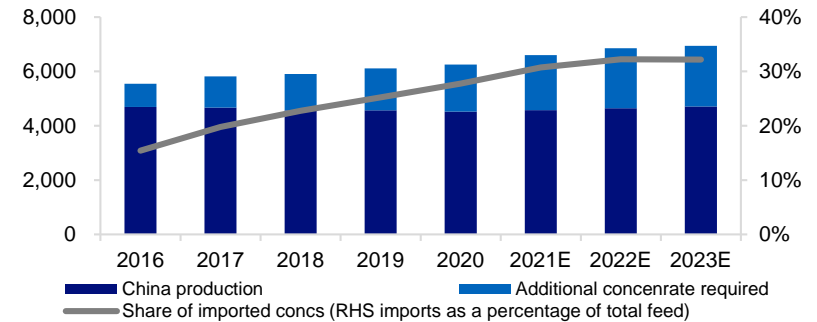

Global Visible Stocks² (kt)

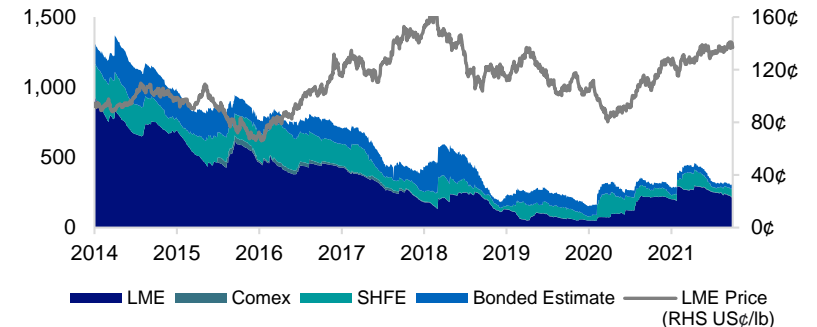

Zinc Market

Raw materials shortages and improving demand support prices

Steel Demand in China Supporting Zinc Price¹

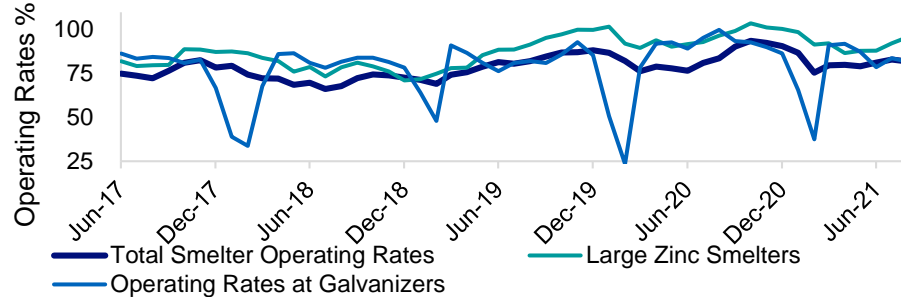

Zinc Tied to the Protection of Steel for 60% of Total Demand²

Zinc Demand 13.1 Mt

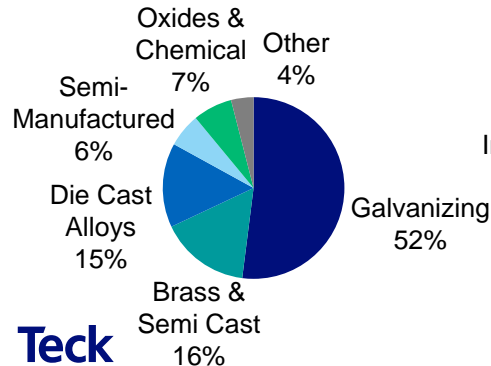

Zinc End Uses 13.1 Mt

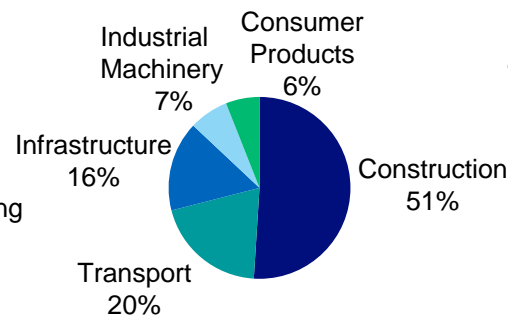

- Demand for raw materials and mine disruptions due to COVID-19 kept concentrate demand strong
 - Mine production in 2020 declined ~1 Mt, while smelter cuts were only ~300 kt
 - Ongoing spread of the virus and COVID-19 protocols continue to impact production in 2021
 - Despite return of mine production, concentrate supply remains tight; Spot TCs have remained stable in 2021, currently at ~US\$80/dmt
 - Concentrate market remained tight in 2021; lower production due to technical issues, delayed ramp-ups, droughts, and ongoing COVID-19 protocols at sites and ports
- Construction, infrastructure, and automobile demand driving zinc demand in China
 - Galvanized utilization rates rebounded after Lunar New Year to 91% in March and has since averaged 86%, well above the long-term average of 78%
 - China zinc premiums remain above ~US\$100/t for ten straight months so far

Chinese Zinc Mine and Smelter Production

Mine production flat while smelter production increases

Chinese Mine Production Flat Since 2018¹
(kt Contained)

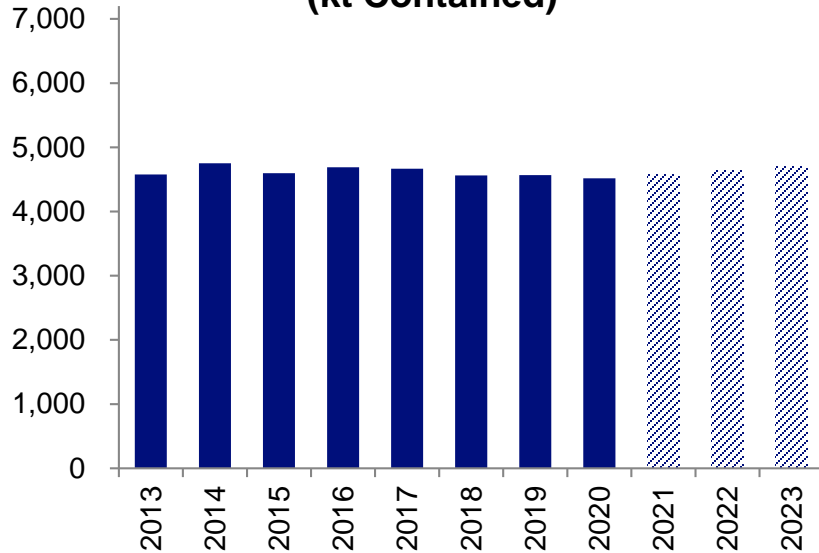

Chinese Refined Production Up 13% Since 2018²
(kt Contained)

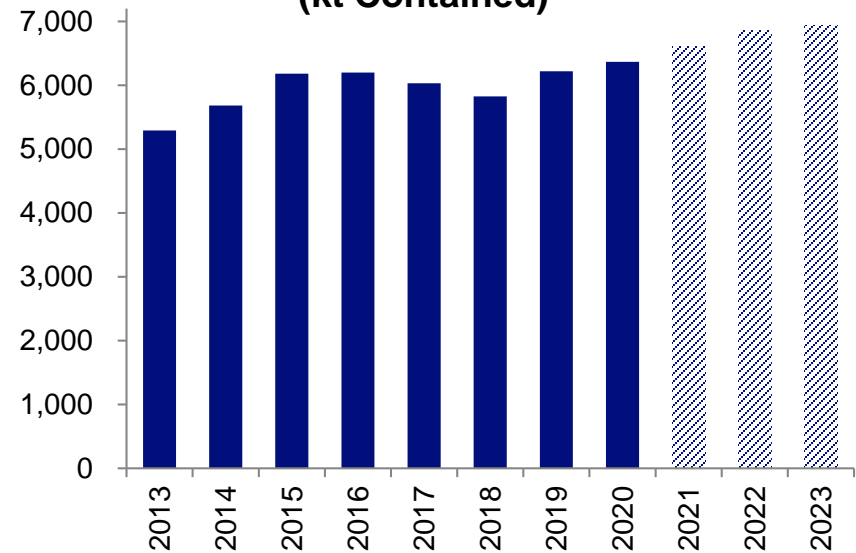

Delayed projects and decreasing ore grades continue to impact Chinese mines

Global Zinc Mine Production Remains Under Pressure

Ongoing risk to supply growth in 2021

Estimated Chinese Zinc Mine Growth Rarely Achieved¹ (Kmt Contained)

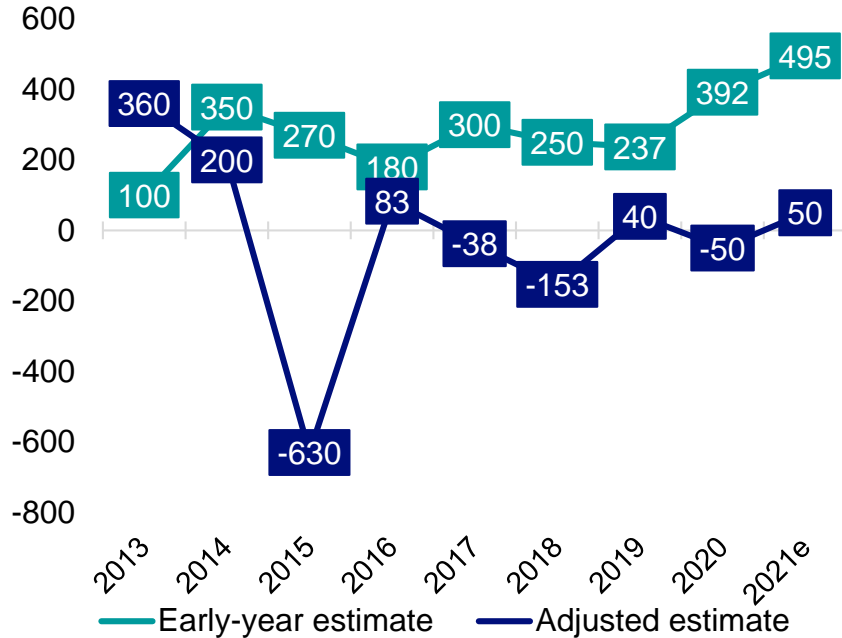

Changes in Mine Production Since Q1 2018²

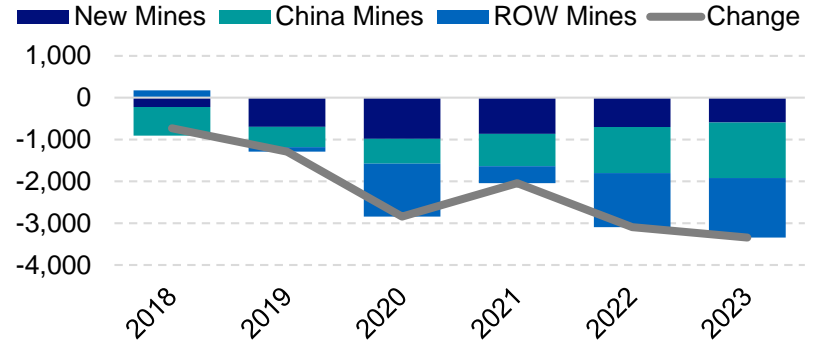

Zinc Ore Grades Falling at Chinese Mines³ (Ore grade, zinc %)

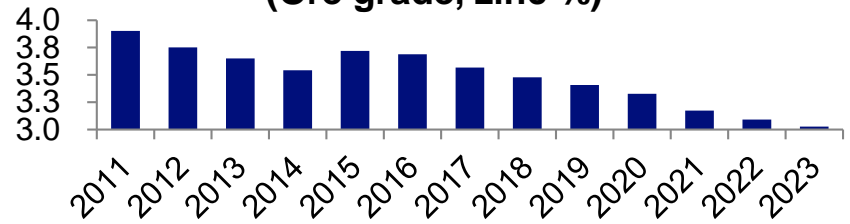

Zinc Stocks Continue to Decrease Despite Refined Production Increases in China

**De-stocking Continues
Chinese Stocks at Record Lows^{1,2} (kt)**

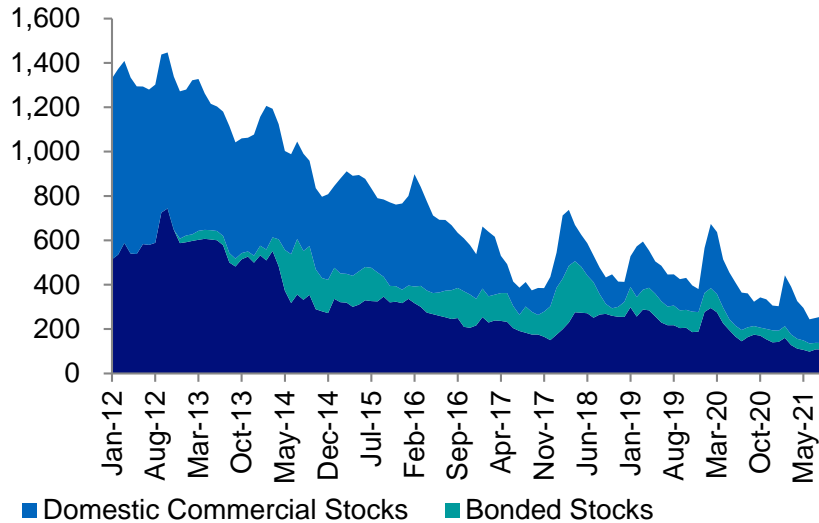

- August 2021 stocks down 23% yoy; down 66% from decade-ago high
- SRB released stocks for first time since 2012 in an attempt to influence prices; Prices have not responded and stocks have remained flat since June
- Additional metal required to meet 2021 demand

**Additional Zinc Metal
Required to Fill the Gap³ (kt)**

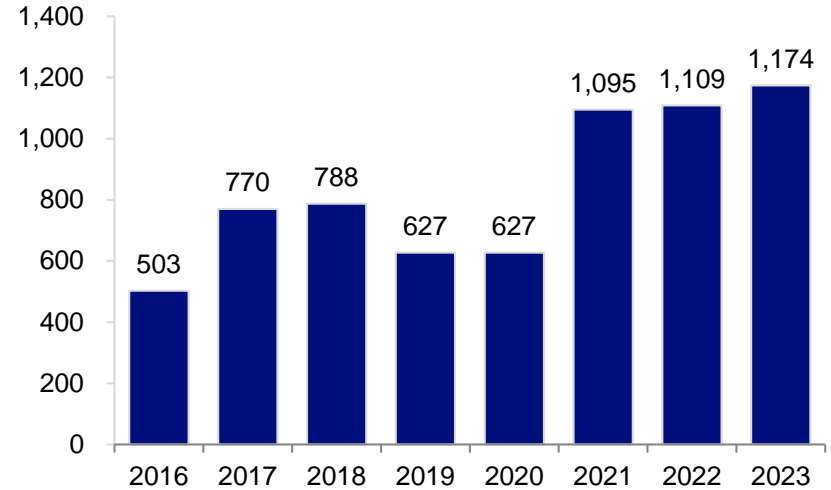

Zinc Supply

Mine production increasing in 2021, but remains at risk due to COVID-19

- Following the return of Chinese mine production after COVID-19 shutdowns, increasing smelter production kept China reliant on imported concentrate
- Chinese mine production decreased 1.6% in 2020 on declining ore grades and delayed projects
- Mine production is recovering in South America, after losing >1.0 Mt of production in 2020; production may return to 2018 levels this year
- 2021 global zinc mine production currently forecast to grow 7.2% over 2020, but up only 3.9% over 2019 levels. Smelter production globally is forecast to be up 5.2% over the same two year period

Zinc Mine Production¹ (kt contained)

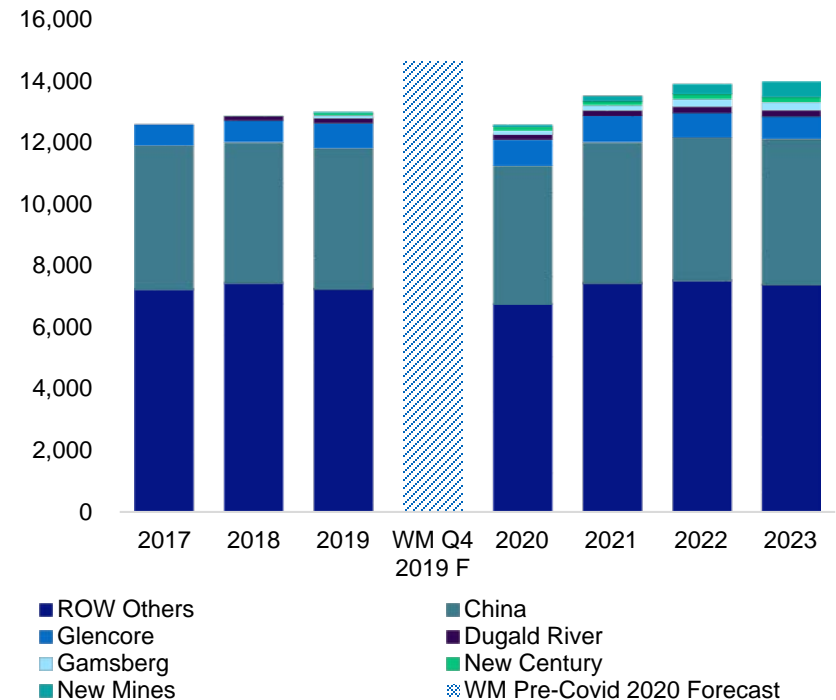

Zinc Concentrate Treatment Charges

Stable in 2021, near historical lows

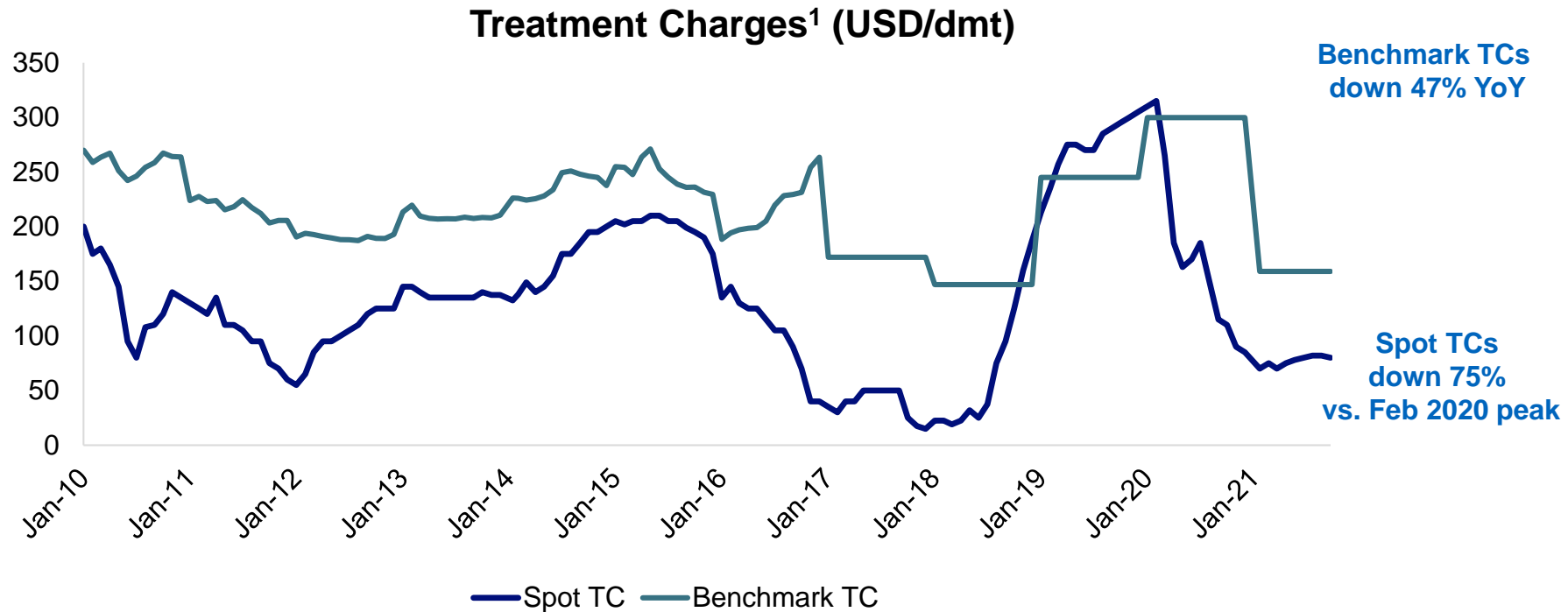

Zinc Metal Stocks

Global shipping backlog unable to keep up with demand causing falling inventory

- Deficits over past 5 years drove down stocks, with total stocks at only 8.1 days of global consumption by the end of September 2021, compared to 38 days in 2012-2013
- Despite rising stocks earlier in the year, escalating demand reduced stock by one third since March 2021 peak
- Total stocks now below low levels from start of 2021
 - LME stocks down 30% since April high of just under 300 kt
 - LME warehouses incentivizing traders to lock up metal on exchange in rent deals
 - SHFE stocks increased 94% since July low, steadily building since August

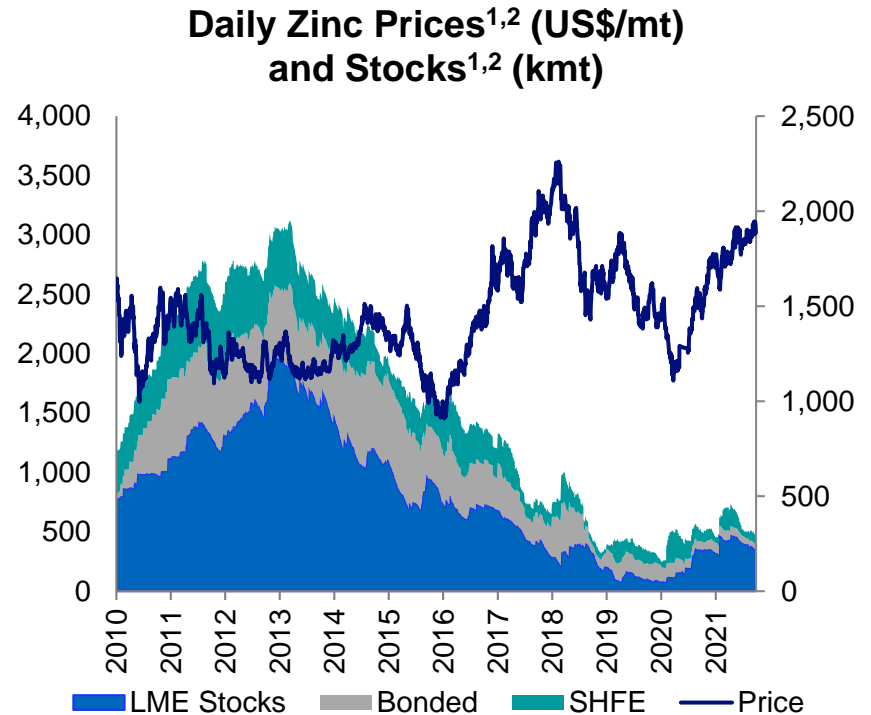

Largest Global Net Zinc Mining Companies

Teck is the Largest Net Zinc Miner¹(kt)

Provides significant exposure to a rising zinc price

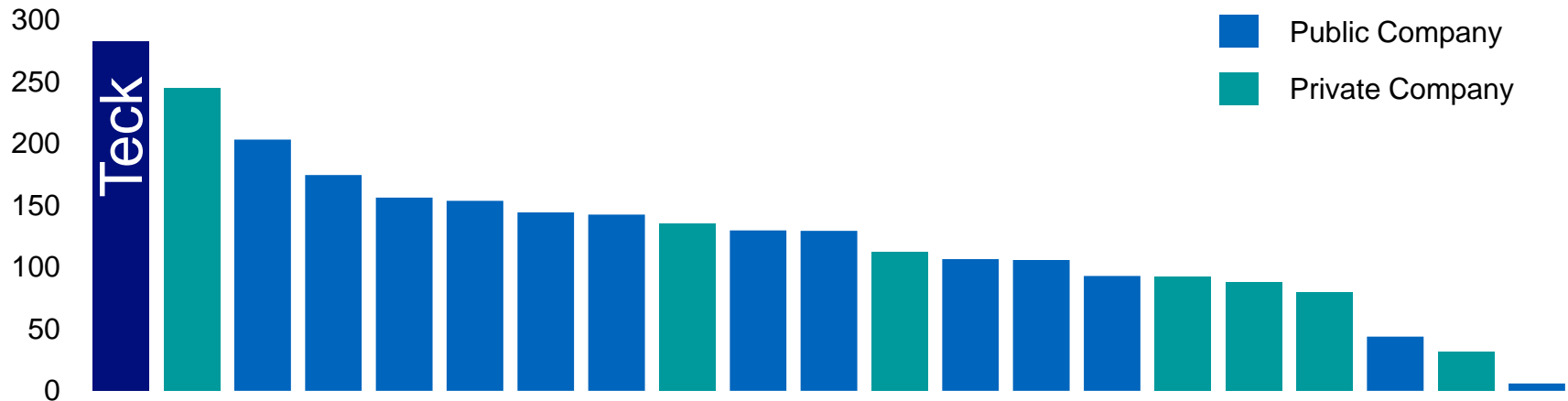

Endnotes: Zinc Market

Slide 103: Zinc Outperforms Market Expectations

1. China zinc concentrate supply requirements 2016 – 2023 estimates. Source: China NBS/CNIA, BGRIMM, Teck.
2. Global Visible Stocks. Source: LME, ICE, SHFE, SMM. To September 30th, 2021.

Slide 104: Zinc Market

1. Source: Shanghai Metal Market.
2. Source: Based on information from the International Zinc Study Group Data.

Slide 105: Chinese Zinc Mine and Smelter Production

1. Source: Data compiled by Teck based on information from BGRIMM, CNIA, Antaike.
2. Source: Data compiled by Teck based on information from BGRIMM, CNIA, Antaike.

Slide 106: Global Zinc Mine Production Remains Under Pressure

1. Source: Data compiled by Teck based on information from BGRIMM, CNIA, Antaike. Early year estimates from consolidation of several analyst views in the year preceding.
2. Source: Data compiled by Teck based on information from BGRIMM, CNIA, Antaike.
3. Source: Data compiled by Teck based on information from BGRIMM, CNIA, Antaike., NBS.

Slide 107: Zinc Stocks Continue to Decrease While Refined Production Increases in China

1. Source: Data compiled by Teck Analysis based on information from SHFE, SMM,
2. Source: "Smelter + consumer stocks" refers to zinc metal held in the plants of smelters and semi producers and those on the road; "Bonded stocks" refers to zinc stored in bonded zones and will need to complete Customs clearance before entering China; "Domestic commercial stocks" refers to zinc stored in SHFE warehouses and other domestic commercial warehouses not registered in SHFE.
3. Source: Data compiled by Teck Analysis based on historic numbers from China Customs, and forecasts based on data from BGRIMM, Antaike and Teck's commercial contacts.

Slide 108: Zinc Supply

1. Source: Data compiled by Teck based on information from Wood Mackenzie, BGRIMM, CNIA, Antaike and Teck analysis.

Slide 109: Zinc Concentrate Treatment Charges

1. Source: Wood Mackenzie.

Slide 110: Zinc Metal Stocks

1. Source: Data compiled by Teck from information from LME, SHFE, SMM.
2. Source: Data compiled by Teck from information from LME, Fastmarkets, Argus, Acuity, company reports.

Slide 111: Largest Global Net Zinc Mining Companies

1. Source: Data compiled by Teck from information from Wood Mackenzie. Company smelter production netted against company mine production on an equity basis.

Steelmaking Coal Business Unit

Teck



Tier-One Steelmaking Coal Portfolio

49%

Steelmaking Coal
12-year Historical Average
Annual Impairment
Adjusted EBITDA Margin¹

\$2.2B

Steelmaking Coal
12-year Historical Average
Annual Impairment
Adjusted EBITDA¹

4

Fully Integrated
Operating Mines

~27

Mtpa
Steelmaking Coal
Production Capacity
(attributable)

- Diversified, long term customer base
- Stable long term strip ratio
- Long term production run rate of 26-27 million tonnes per annum
- Positive social license with a history of 50+ years of continuous operations
- Integrated operations and supply chain with dedicated market access

Proven commitment to responsible mining through innovation

Steelmaking Coal Operating Strategy

Optimized Supply Chain

- Improved market access and reliability for customers
- Pit to port integration maximizes short and long term Elk Valley synergies

Increase Margins Not Volumes

- Strategically replaced high cost tonnes with low cost tonnes – **Elkview Plant Expansion**
- Leveraging technology to lower unit costs and increase throughput – **RACE**

Innovation Drives Best in Class Productivity and Asset Utilization

- Leaders in haul truck productivity improvement
 - Record 2020 haul truck productivity
- Asset life cycle optimization to minimize capital investment requirements; Advanced plant & mining analytics

Commitment to Strong Social and Environmental Performance

- Improving water quality
- Reducing carbon footprint

Map and Production Capacity¹

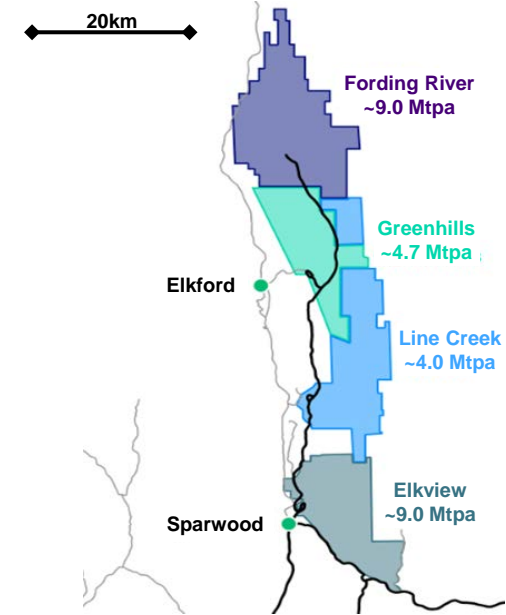

-800 Mt of reserves² support long term production run rate of 26-27 million tonnes per annum

Executing on the Elk Valley Water Quality Plan

Active Water Treatment Facilities (AWTF)

- Tank based biological treatment process removes nitrate and transforms selenium into a solid form

Saturated Rock Fill (SRF)

- Uses naturally-occurring biological process in old mining areas that are backfilled with rock and saturated with water

Saturated Rock Fill (SRF)

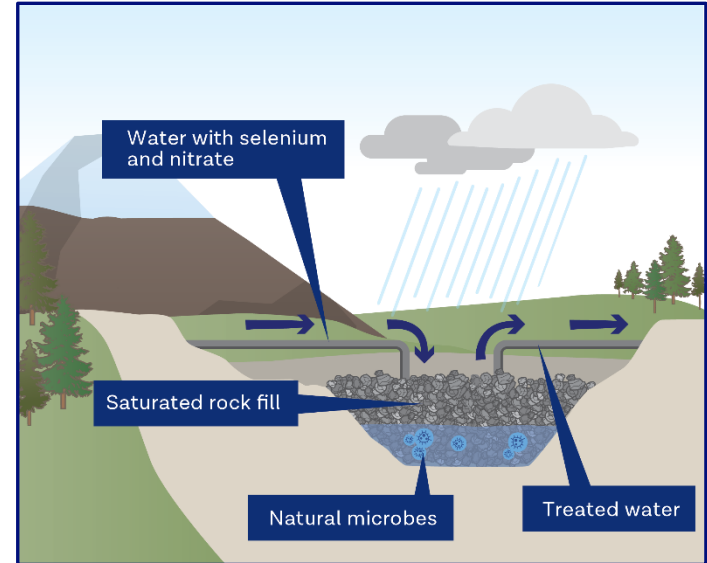

Tripling treatment capacity in 2021 >50 million litres per day; 90 million litres per day by 2025

Optimally Positioned For a Decarbonizing Future

- Teck's premium hard coking coal improves blast furnace efficiency and decreases CO₂ emissions per tonne of steel
- Within the lowest carbon performance of the commodity range, assisted by access to low carbon sources of electricity in B.C.
- Evaluating renewable and alternative energy sources and storage capabilities and introducing efficient and emissions-free fleet technology

Steelmaking Coal CO₂ Intensity Curve¹ (t CO₂e/t saleable coal)

Will be even more cost competitive
with rising CO₂ prices globally

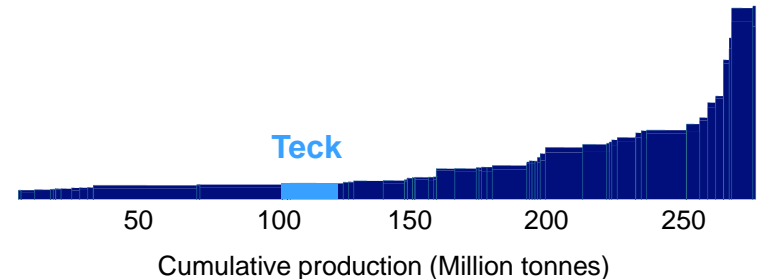

Highest quality HCC leading to amongst the lowest CO₂ emissions in steelmaking coal

Proven Operator, Managing for Margin And Costs Through Cycles

Low Price Environment

Cost focus to protect margins and maximize Free Cash Flow¹

- ★ 2013: Cost Reduction Program (CRP) is introduced
- 1 2013-2016: Operating Excellence drives cost reduction and productivity improvement
- 3 2020: CRP in response to pandemic disruption

High Price Environment

Production focus to capture high margins and maximize Free Cash Flow¹

- 2 2016-2019: Historic bull-run focused on maximizing Free Cash Flow¹
- 4 Q4 2020+: Product and sales strategy to maximize record CFR China prices

Steelmaking Coal Impairment Adjusted EBITDA¹ & Impairment Adjusted EBITDA Margin¹ (%)

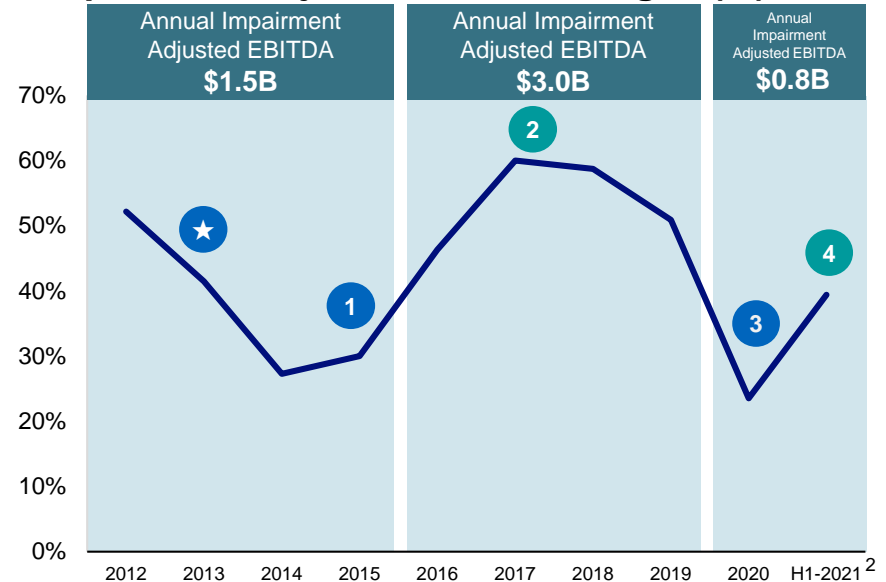

Strong EBITDA¹ and EBITDA Margin¹ generation potential through all cycles

Top Quartile Margins in Steelmaking Coal

Managing our Core Business Drivers to Optimize Margins

- Neptune capacity increase and third-party logistics contracts
 - Lowering port costs, increase logistics chain flexibility and improved reliability
- RACE21™ transformation
 - Lowering operating costs and increasing EBITDA¹ potential
- Stable long term strip ratio, maintaining best in class truck productivity
- Strong margins in any market with exceptional cash generating potential

Strong Cash Flow Generation Potential²

	Clean Coal Production per Annum	Change	Estimated Effect on Annualized Profit ³	Estimated Effect on Annualized EBITDA ³
Coal	26 Mt	US\$50/t	C\$950M	C\$1,500M

Seaborne Steelmaking Coal Delivered Operating Margin⁴

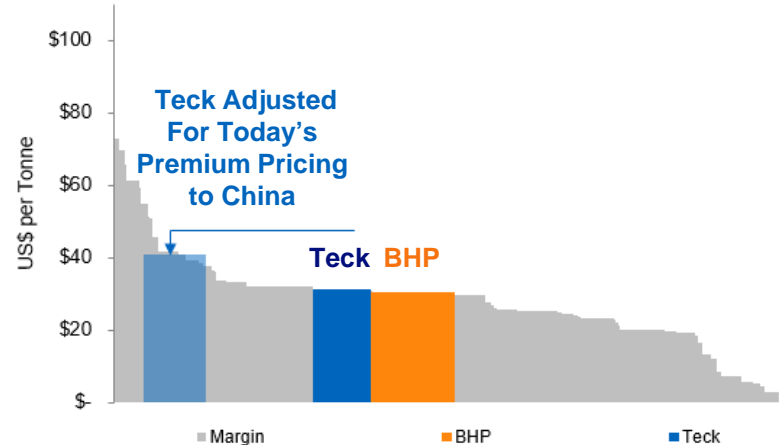

Steelmaking coal competitively positioned to continue to deliver strong returns

Steelmaking Coal Unit Costs

Unit Costs¹ in 2020

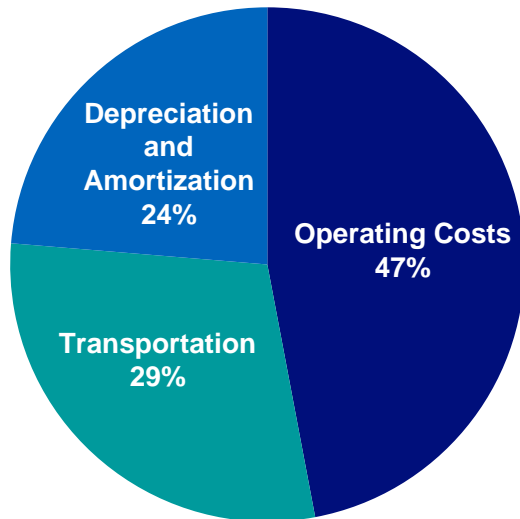

Operating Cost¹ Breakdown in 2020

Labour	34%
Contractors and Consultants	13%
Operating Supplies	16%
Repairs and Maintenance Parts	19%
Energy	14%
Other	4%
Total	100%

Sustain Production Capacity and Productivities In Steelmaking Coal

Maintaining historical dollar per tonne sustaining investment levels

2010-2016: Average spend of ~\$11 per tonne¹

- Swift at Fording River and Line Creek
- Reinvestment in 5 shovels, 50+ haul trucks

2017-2024: Average spend of ~\$11-13 per tonne¹

- Plant expansion at Elkview, mine life extension projects and Neptune sustaining investments
- Reinvestment in equipment fleets and infrastructure to increase mining productivity and processing efficiencies

Sustaining Capital, Excluding Water Treatment¹ (\$/t)

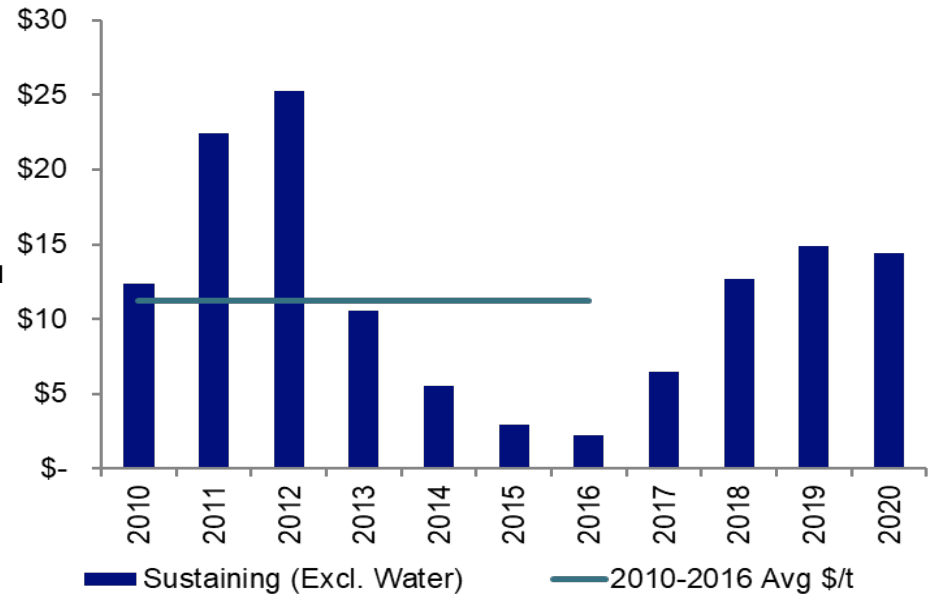

Long term run rate for sustaining capital is ~\$11-13 per tonne

Haul Truck Rebuild Strategy

Potential to significantly reduce capital costs

Significant benefits from moving to a haul truck rebuild strategy, vs. replacing 930E trucks after ~100,000 hours

- Reduces capital spending for new truck purchases
- Increases fleet operating hours
- Reduces fleet operating costs

Expected to reduce capex by ~\$360 million¹ over 10 years, with an NPV of ~C\$235 million and a payback of ~3.9 years

- Includes rebuilding engines and truck beds; opportunity to further reduce capex requirements by rebuilding frames
- Assumes cost savings of C\$3.4 million per truck, or 47%, based on the cost of a new 930E 5 truck of C\$7.2 million and the cost of an average 930E 4 rebuild of C\$3.8 million
- Smooths capital costs over the next 10 years and avoids the purchase of >100 new haul trucks

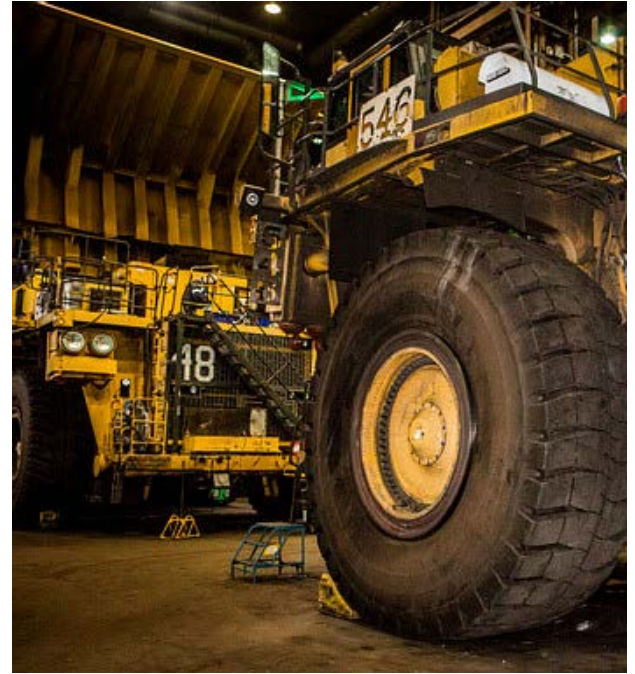

Opportunity to extend the program to other vehicles in the fleet

West Coast Port Capacity

NEPTUNE COAL TERMINAL



- World class design and equipment for enhanced reliability
- Capacity growth to >18.5 Mtpa
- ~\$150M infrastructure investment in upstream supply chain
- 100% ownership of coal capacity

WESTSHORE TERMINALS



- Current capacity 35 Mtpa
- Teck contracted capacity, following expiry of our current contract on March 31, 2021:
 - 2021: 12.55-13.55 Mt, including ~5 Mt in Q1 2021
 - From 2022: 5-7 Mtpa at fixed loading charges
 - Total of 33 Mt over agreement term

RIDLEY TERMINALS



- Current capacity 18 Mtpa
- Teck contract:
 - January 2021 to December 2027
 - Ramps up to 6 Mtpa over 2021

Teck's Contracted West Coast Port Capacity (Nominal Mt)

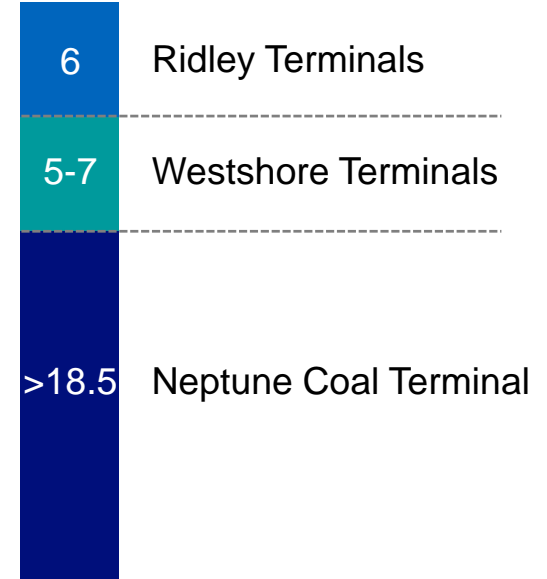

Endnotes: Steelmaking Coal Business Unit

Slide 114: Tier-One Steelmaking Coal Portfolio

1. The 12-year historical average annual Impairment Adjusted EBITDA and Impairment Adjusted EBITDA Margin are for the 2009 to 2020 period, inclusive. Impairment Adjusted EBITDA and Impairment Adjusted EBITDA Margin are non-GAAP financial measures. See "Non-GAAP Financial Measures" slides.

Slide 115: Steelmaking Coal Operating Strategy

1. Metallurgical Clean Coal production capacity from Teck's 2020 Annual Information Form, shown on an attributable basis to Teck (80% Greenhills).
2. Metallurgical Clean Coal Mineral Reserves from Teck's 2020 Annual Information Form. Reserves is shown on a mine and property total and is not limited to Teck's proportionate interest, annual production supported by reserves is shown on an attributable basis to Teck (80% Greenhills).

Slide 117: Optimally Positioned For a Decarbonizing Future

1. Source: Skam Associates, Q2 2021 update to 2020 dataset for global carbon intensity performance of steelmaking coal assets. Includes Scope 1 and 2 emissions.

Slide 118: Proven Operator, Managing for Margin and Costs Through Cycles

1. Free Cash Flow, EBITDA, Impairment Adjusted EBITDA, EBITDA Margin, Impairment Adjusted EBITDA Margin are non-GAAP financial measures. See "Non-GAAP Financial Measures" slides.
2. Annualized.

Slide 119: Top Quartile Margins in Steelmaking Coal

1. EBITDA is a non-GAAP financial measure. See "Non-GAAP Financial Measures" slides.
2. Sensitivities from Teck's 2020 Annual Report. The sensitivity of our annual profit attributable to shareholders and EBITDA to changes in the Canadian/U.S. dollar exchange rate and commodity prices, before pricing adjustments, based on a 26.0 million tonne production volume estimate, our current balance sheet, current commodity prices and a Canadian/U.S. dollar exchange rate of \$1.30. See Teck's Q4 2020 press release for further details.
3. The effect on our profit attributable to shareholders and on EBITDA of commodity price and exchange rate movements will vary from quarter to quarter depending on sales volumes. Our estimate of the sensitivity of profit and EBITDA to changes in the U.S. dollar exchange rate is sensitive to commodity price assumptions. EBITDA is a non-GAAP financial measure. See "Non-GAAP Financial Measures" slides.
4. Source: Teck, Wood Mackenzie Seaborne Metallurgical Coal Cost Curve August 2021. Teck's total cost includes royalties normalized to Wood Mackenzie's 2021 FY FOB Australia HCC price assumption of US\$130.74 per tonne.

Slide 120: Steelmaking Coal Unit Costs

1. Steelmaking coal unit costs are reported in Canadian dollars per tonne. Non-GAAP financial measures. See "Non-GAAP Financial Measures" slides.

Slide 121: Sustain Production Capacity and Productivities in Steelmaking Coal

1. Historical spend has not been adjusted for inflation or foreign exchange. 2021-2025 average spend assumes annualized average production of 27 million tonnes. All dollars referenced are Teck's portion net of POSCAN credits for Greenhills Operations at 80% and excludes the portion of sustaining capital relating to water treatment. Sustaining capital is now inclusive of production capacity investments previous called Major Enhancement. Excludes capital leases and growth capital.

Slide 122: Haul Truck Rebuild Strategy

1. Assumes 107 trucks rebuilt over a ten-year period and an 8% discount rate.

Steelmaking Coal Market



Steelmaking Coal Facts

Global Coal Production¹:

~7.4 billion tonnes

Steelmaking Coal Production²:

~1,130 million tonnes

Export Steelmaking Coal²:

~320 million tonnes

Seaborne Steelmaking Coal²:

~285 million tonnes



- ~0.7 tonnes of steelmaking coal is used to produce each tonne of steel³
- Up to 100 tonnes of steelmaking coal is required to produce the steel in the average wind turbine⁴

Our market is seaborne hard coking coal²: ~190 million tonnes

Steelmaking Coal Prices Resilient Despite Import Ban

Australian banned exports absorbed by strong steel market

Steelmaking coal prices diverge on import ban

- CFR prices into China hit all time high
- Chinese steel production continues to grow at 1.1 Gt annualized YTD
- Chinese mine supply constrained on quality, logistics, and ongoing safety inspections
- Imports from Mongolia constrained due to COVID-19
- Ten-year average seaborne FOB price of ~US\$170/t, or US\$180/t on an inflation-adjusted basis¹

Steel prices support steel mill margins

- Steel prices hit record highs in 2021 across all markets
- Current order books well supported into 2022
- Strong demand led to record steel prices, incentivizing production and supporting raw material prices

Steelmaking Coal Prices¹ (US\$/t)

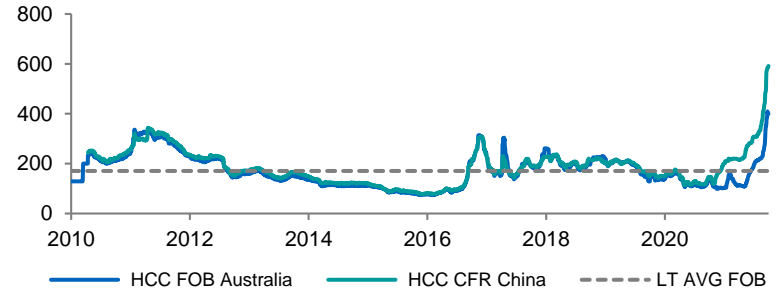

Hot Rolled Coil Prices (US\$/t)

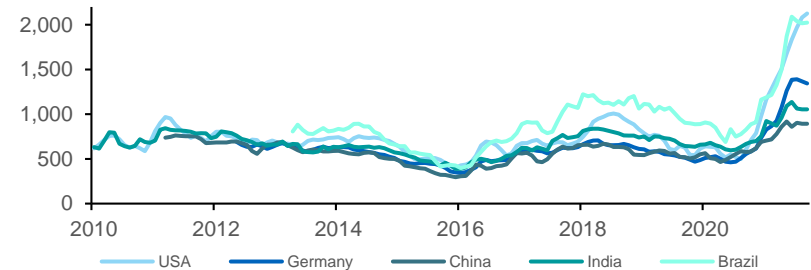

Rising demand exceeds market's ability to adjust to trade dispute

Australian Coal Ban Absorbed

Displaced Australian coal taken up by ex-China market

Australian HCC finds new homes; market pivots

- Australian coal banned; ROW to fill the Chinese gap
- Australian exports to China drop to zero from ~34 Mt
- Increased demand ex-China & repositioning absorbed Australian surplus; took market ~6 months to sort out logistics/supply
- No indication of change to import ban into 2022

China remains short steelmaking coal

- China relied on increased domestic production, imports from Mongolia, Canada/USA & others
- Mongolia down 7% YTD due to COVID-19 (2021: -8.6 Mt)
- Domestic production up 3% YTD, estimated +9 Mt for 2021
- Seaborne imports ex-Australia up 136% YTD, estimated +16 Mt for 2021
- China short ~13–20 Mt this year based on historic imports and production

Australian HCC Exports¹ (Mt)

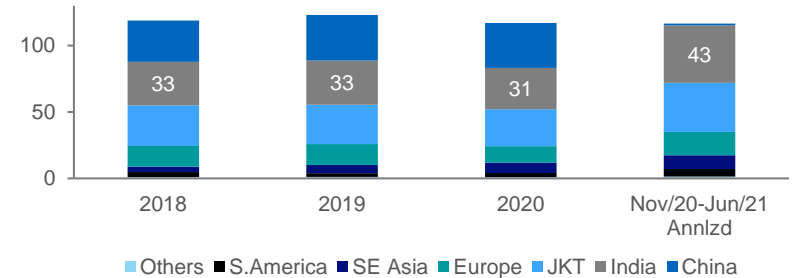

China HCC Imports² (Mt)

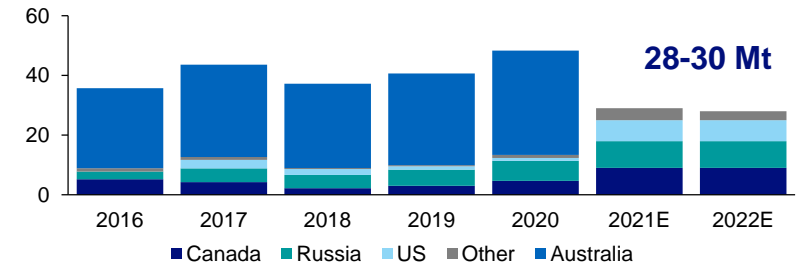

Teck capitalizing on Chinese market opportunity while maintaining existing contracts

Long Term Steelmaking Coal Demand Well Supported

Planned blast furnace capacity set to grow

Asian blast furnace capacity continues to grow

- Asia committing to 20+ years of traditional steel making
- European steel mills seek alternatives to coal feed
- Hydrogen pilot plants only, commercial technology still decades away and currently prohibitively expensive
- Seek alternative carbon abatement in CCS/CCUS

Blast Furnace Capacity² (Mt)

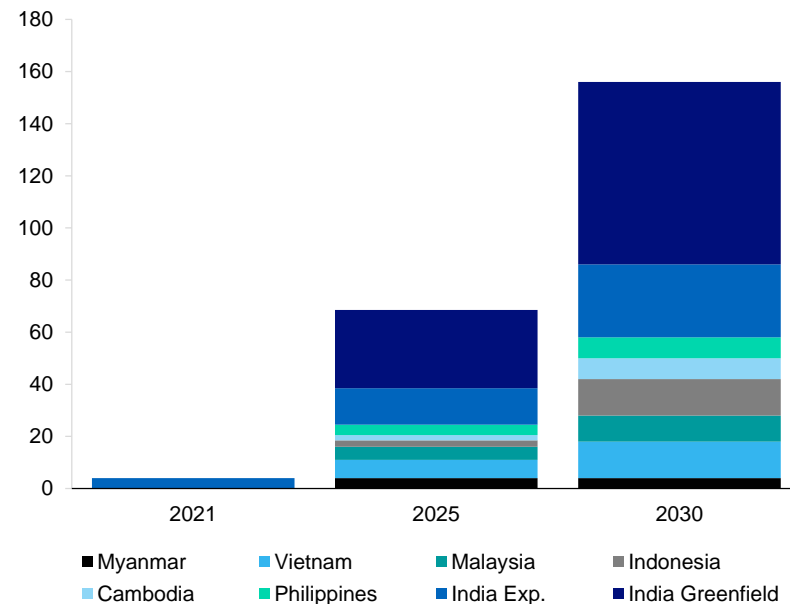

India¹

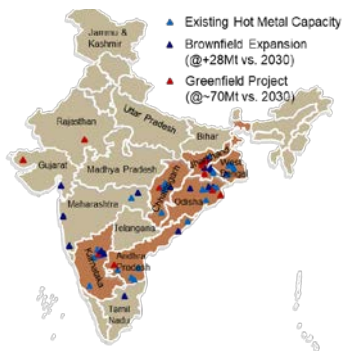

South-East Asia¹

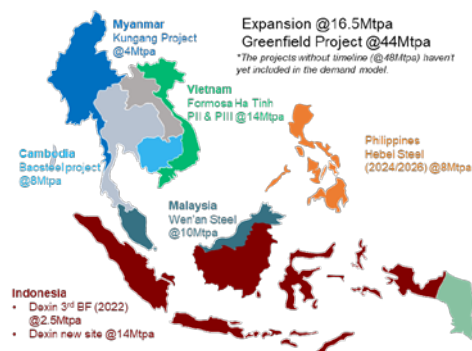

Financial commitments being made for multi-decade traditional steel making

Steelmaking Coal Demand Growth Forecast

Continued recovery with majority of banked blast furnaces restarted

Seaborne Steelmaking Coal Imports¹ (Mt)

Change 2021 vs. 2019

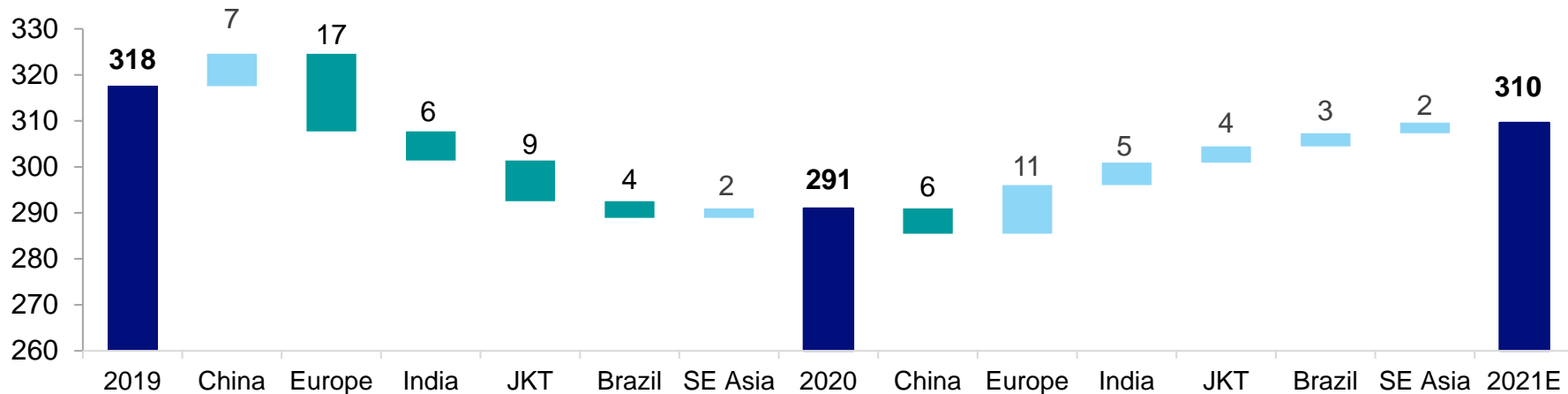

Includes:

- China: Impact of the ban on Australian coal, domestic production flat, Mongolian imports down further
- Europe/JKT: All banked furnaces restarted

- India: Growing steel production; unchanged long-term fundamentals
- Brazil: Strong domestic demand (residential construction, automotive) and export market
- SE Asia: Economic recovery

Indian Steelmaking Coal Imports

Mid- & long-term imports supported by strong demand and government targets

Indian Crude Steel Production¹ (Mt)

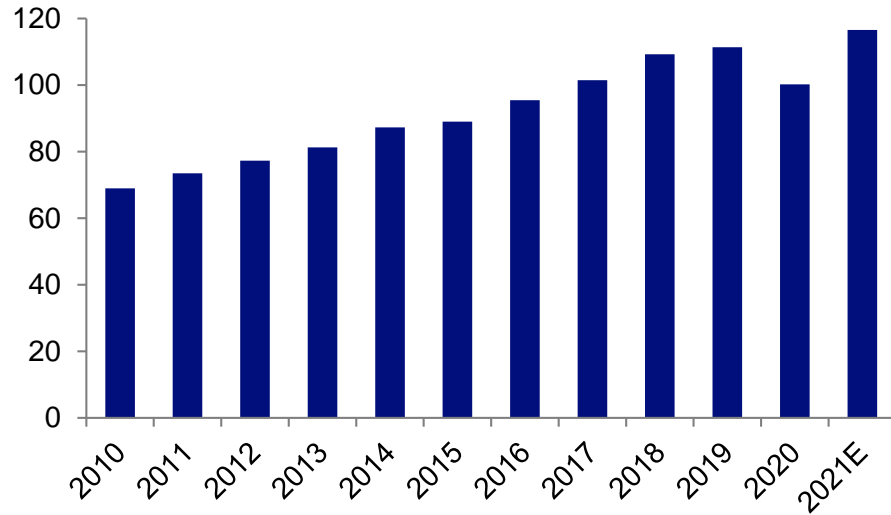

Indian Seaborne Coking Coal Imports² (Mt)

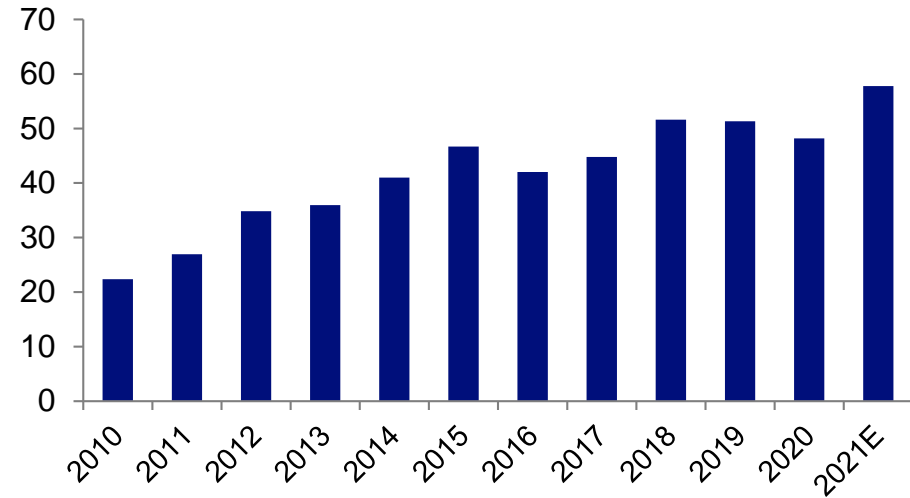

India 2021 crude steel production and seaborne coking coal imports surpassing 2019 levels

Chinese Steelmaking Coal Imports – Australia Ban

2021 seaborne imports down by -22 Mt with ex-Australia up +8 Mt YTD

Chinese Crude Steel Production (CSP), Hot Metal Production (HMP) and Coal Production (Mt)¹

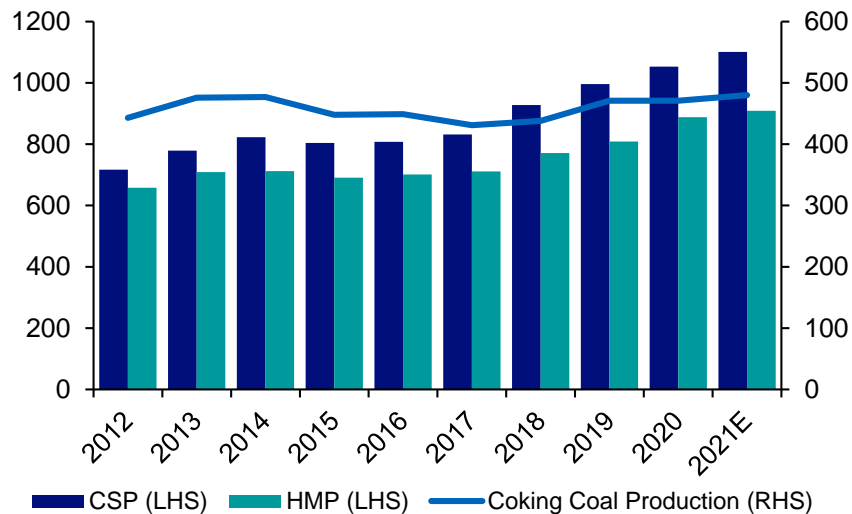

Chinese Coking Coal Imports² (Mt)

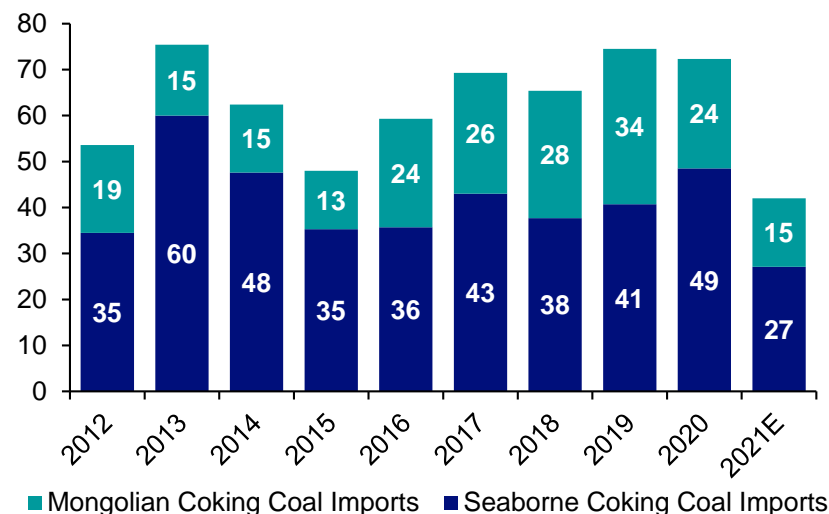

China domestic production up 3%, Mongolia imports down -21%

- +8.7 Mt YoY for domestic coking coal production... safety inspections limit growth forward
- -2.7 Mt YoY for Mongolian coking coal imports... pandemic closes borders reduces imports

Chinese Steel Margins

Steel margins rebound on record high steel prices

China Hot Rolled Coil (HRC) Margins and Steelmaking Coal (HCC) Prices¹ (US\$/t)

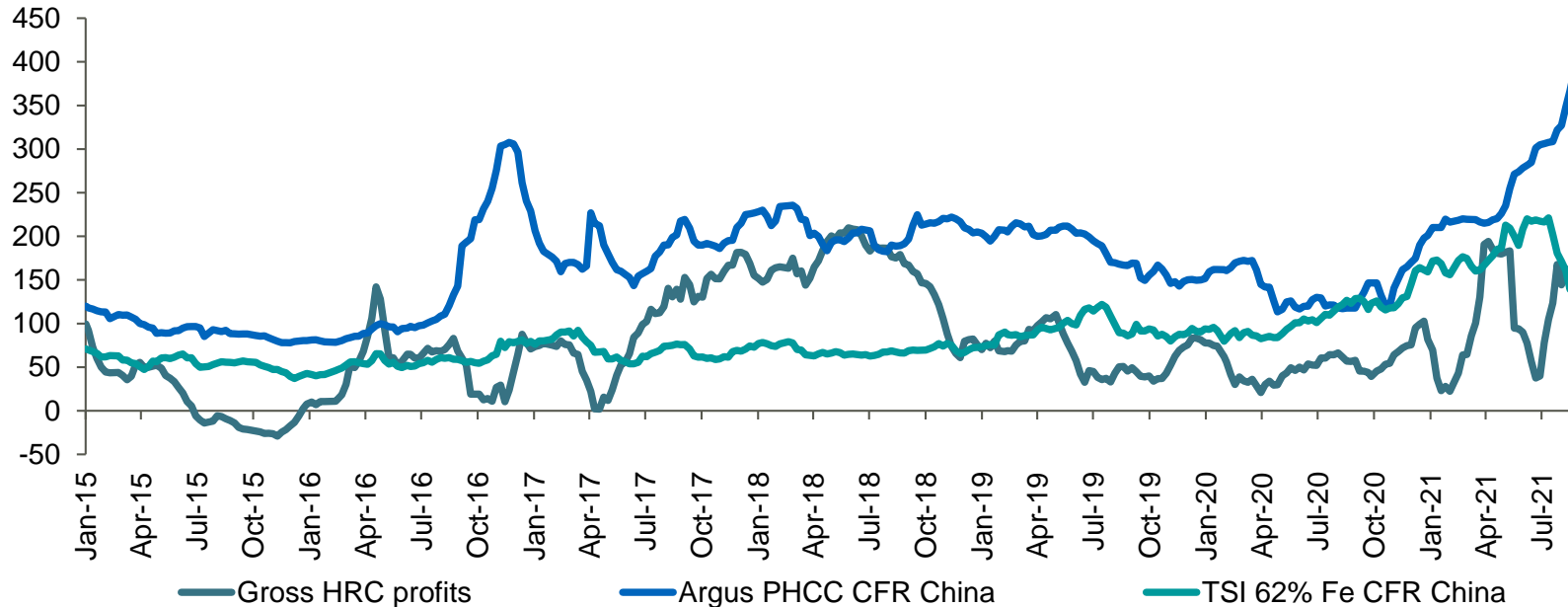

Chinese Scrap Use Remains Low

Scrap supply limits EAF share in steel output

China's scrap ratio lower than global average of 38%¹
(2019)²

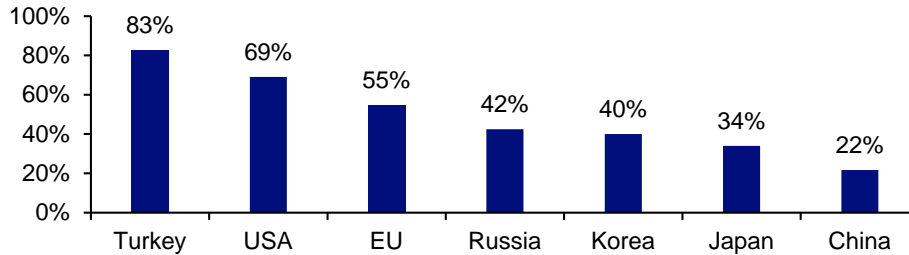

2025 EAF share forecast to be similar to 2010⁴

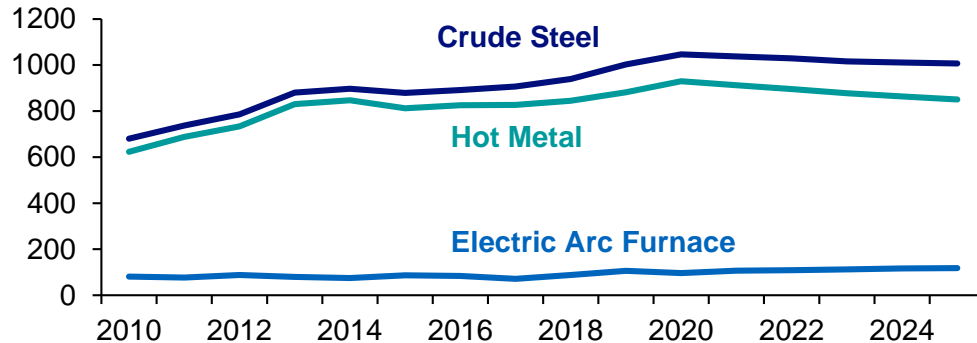

China Steel Use By Sector
(2000-2020)³

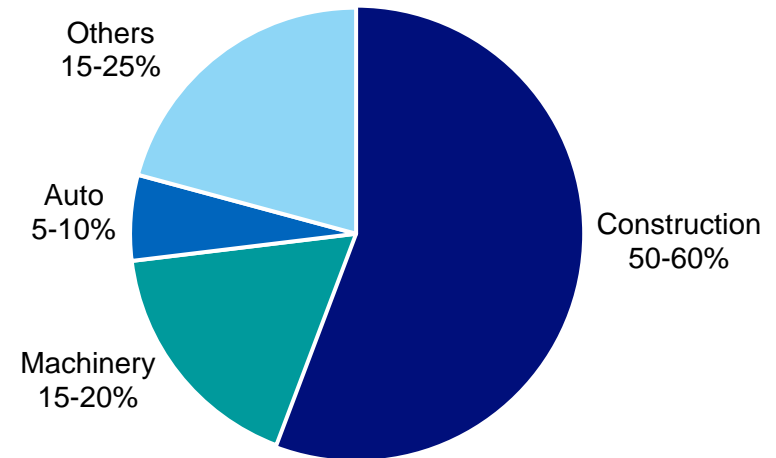

Steelmaking Coal Supply Growth Forecast

Supply forecast to recover; while crude steel production up significantly

Seaborne Steelmaking Coal Exports¹ (Mt)

Change 2021 vs. 2019

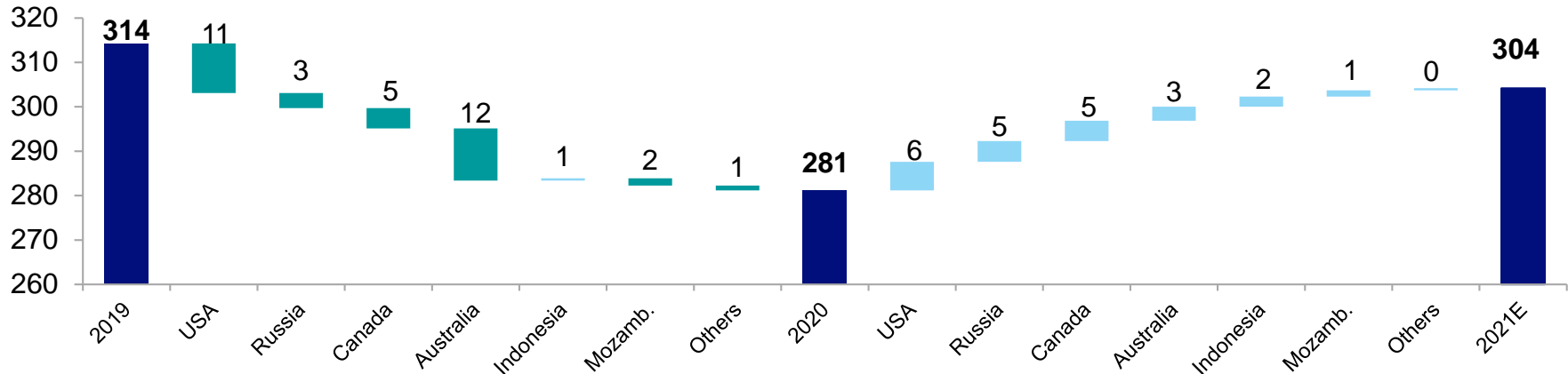

- USA: YTD exports up 5% on higher CFR prices, but still down 17% over 2019 on production/logistics issues
- Russia: Higher exports possible but railways key to new projects. Spot rail car rates double over last year.

- Canada: Growth restricted due to wildfires
- Mozambique: still not at 2019 levels.
- Australia: Production to increase in 2022

Crude steel production up ~125 Mt over 2019 levels; Steelmaking coal exports down ~10 Mt

Australia and US Steelmaking Coal Exports

2021 Australia and US coal exports down vs. 2019

Australian Exports¹ (Mt)

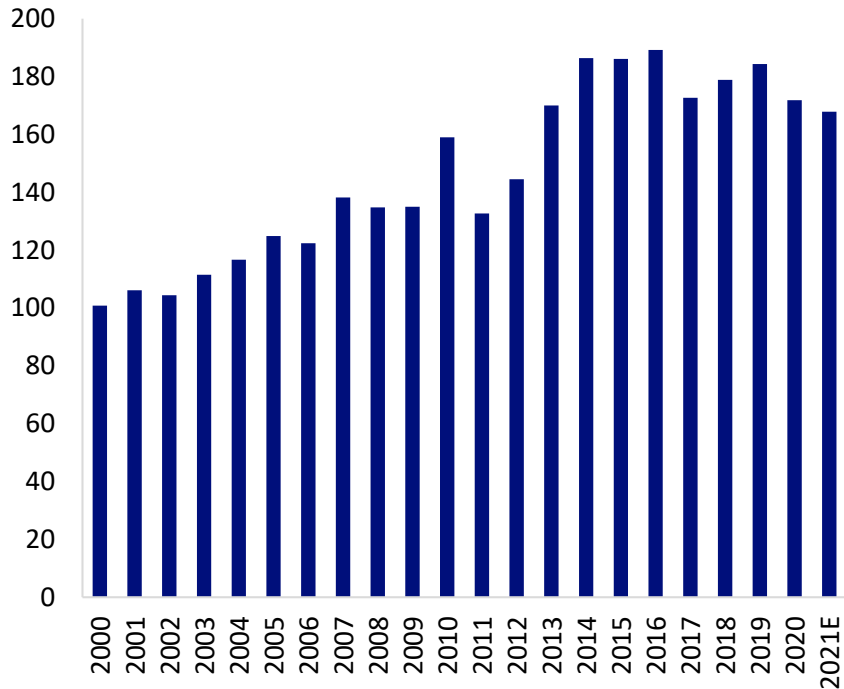

US Exports² (Mt)

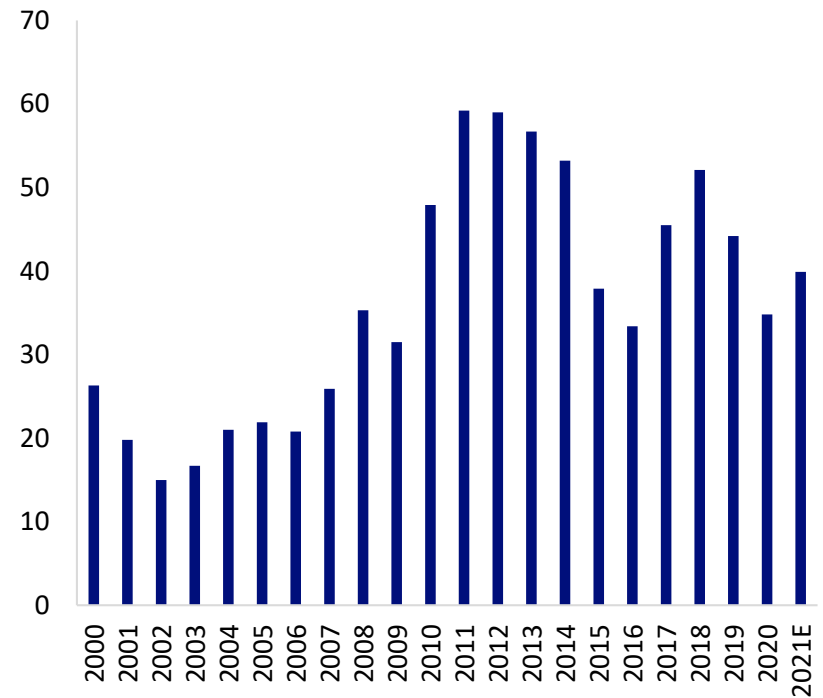

Canadian & Mozambique Steelmaking Coal Exports

2021 Canadian exports impacted by B.C. wildfires

Canadian Exports¹ (Mt)

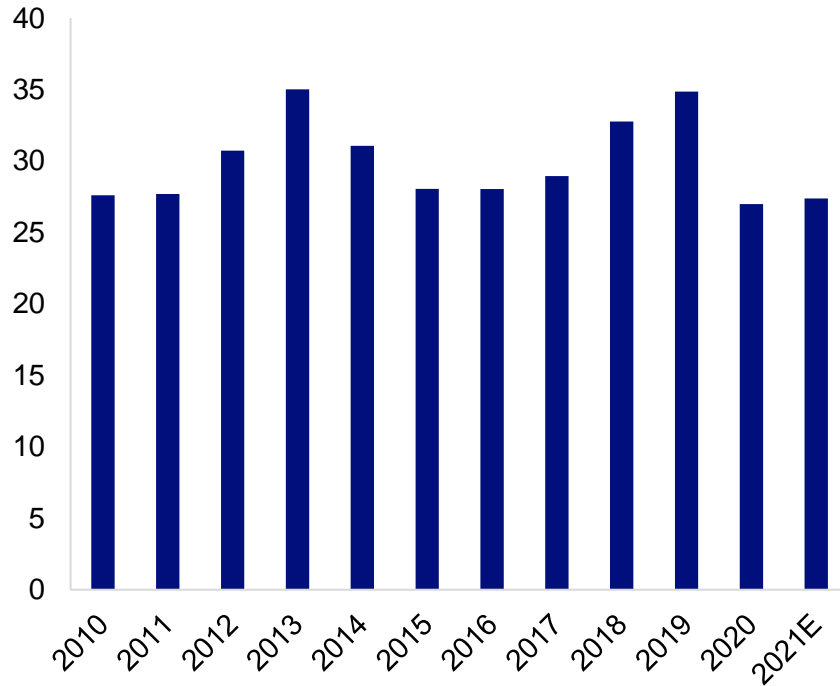

Mozambique Exports² (Mt)

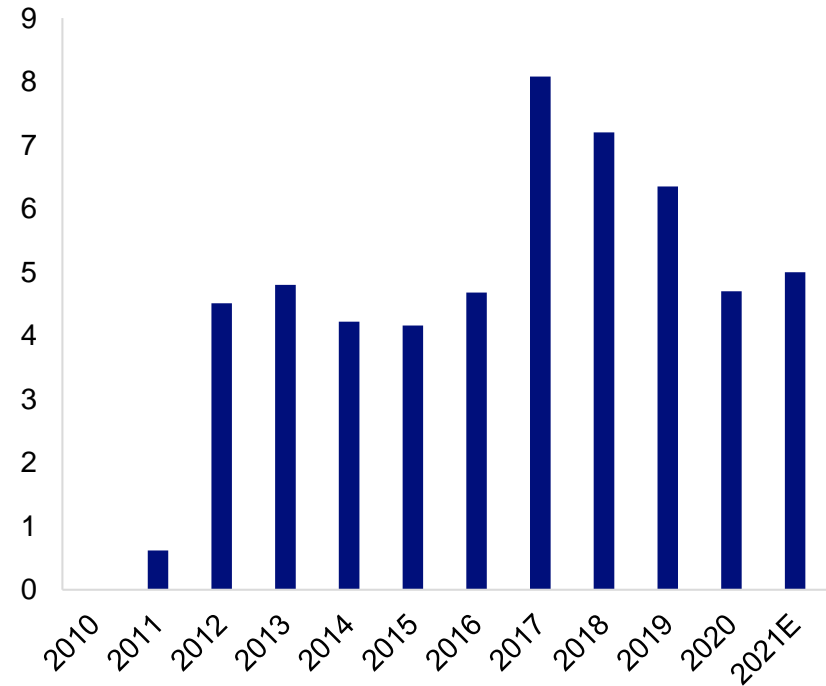

2nd Largest Seaborne Steelmaking Coal Supplier

Competitively positioned to supply steel producers worldwide

Sales Distribution

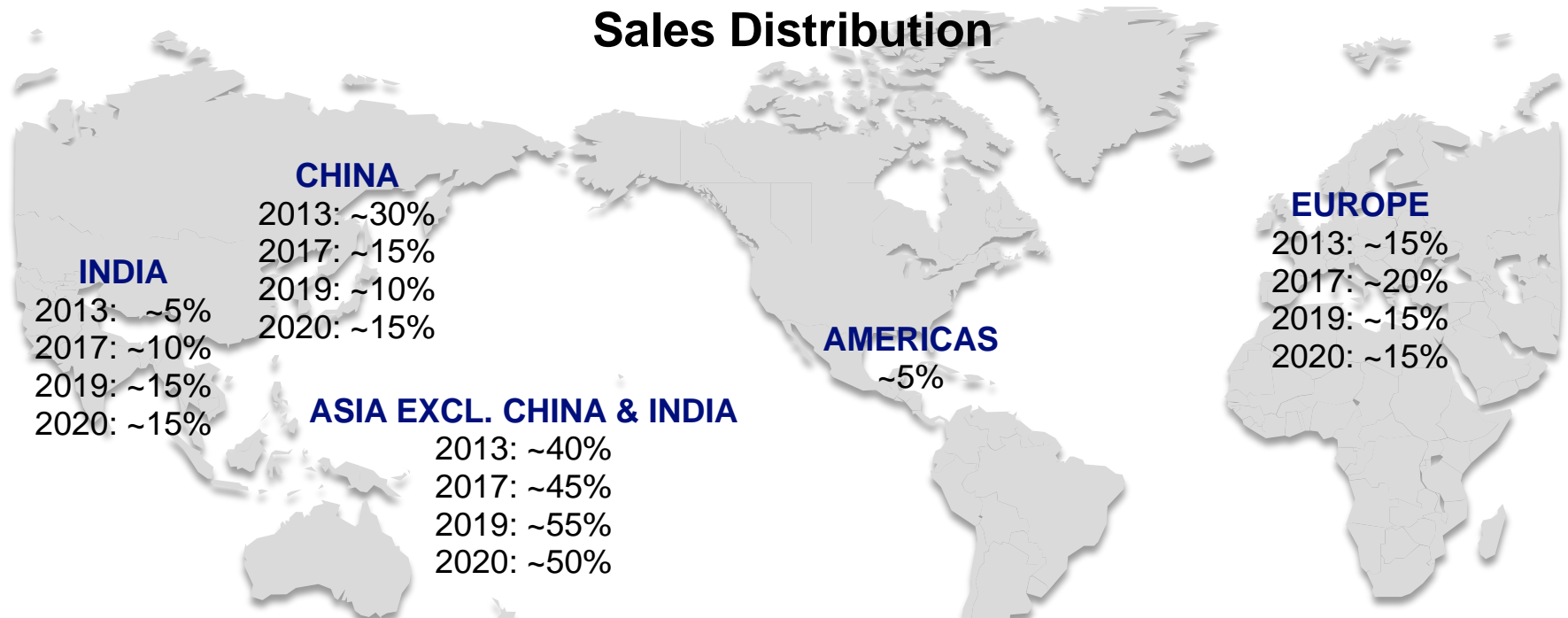

Targeting increased sales to China to capture current CFR China price premium

Endnotes: Steelmaking Coal Market

Slide 126: Steelmaking Coal Facts

1. Source: IEA.
2. Source: Wood Mackenzie (Long Term Outlook H2 2020).
3. Source: World Coal Association. Assumes all of the steel required is produced by blast furnace-basic oxygen furnace route.
4. Source: The Coal Alliance. Assumes all of the steel required is produced by blast furnace-basic oxygen furnace route.

Slide 127: Steelmaking Coal Prices Resilient Despite Import Ban

1. Ten-year steelmaking coal prices are calculated from January 1, 2011. Inflation-adjusted prices are based on Statistics Canada's Consumer Price Index. Source: Argus, Teck. As at September 28th, 2021.
2. Ten-year steel hot rolled coil. Source: CRU, Teck. As at September 28th, 2021

Slide 128: Australian Coal Ban Absorbed

1. Australian hard coking coal exports by market 2018 – 2020 and post ban annualized (November 2020 – June 2021 Actuals) in millions of tonnes. Source: IHS/GTIS, Australian Bureau of Statistics.
2. Chinese hard coking coal imports by country of origin 2016 to 2020 with estimates for 2021 based on exports to June/July 2021 annualized. Estimates for 2022 based on currently projected production increases and no change to import ban observed by market analysts as at September 2021. Source: IHS/GTIS, Teck, Wood Mac, CRU. As at September 15th, 2021

Slide 129: Steelmaking Coal Market

1. Ten-year steelmaking coal prices are calculated from January 1, 2011. Inflation-adjusted prices are based on Statistics Canada's Consumer Price Index. Source: Argus, Teck. As at May 13, 2021.

Slide 130: Steelmaking Coal Demand Growth Forecast

1. Source: Data compiled by Teck based on information from Wood Mackenzie (Short Term Outlook March 2021).
2. Source: Data compiled by Teck based on information from (Metallurgical Coal Market Outlook March 2021)

Slide 131: Indian Steelmaking Coal Imports

1. Source: Data compiled by Teck based on information from WSA.
2. Source: Data compiled by Teck based on information from Global Trade Atlas. 2021E is an annualized number based on the 2021 year to date actual.

Slide 132: Chinese Steelmaking Coal Imports – Australian Ban

1. Source: China HRC Gross Margins is estimated by Mysteel. China Domestic HCC Price is Liulin #4 price sourced from Sxcoal and is normalized to CFR China equivalent. Seaborne HCC Price (CFR China) is based on Argus Premium HCC CFR China. Plotted to April 16, 2021.
2. Source: Data compiled by Teck based on information from China Customs and Wood Mackenzie (Short Term Outlook January 2021). 2021 is based on information from Wood Mackenzie.

Slide 133: Chinese Steel Margins

1. Source: China HRC Gross Margins is estimated by Mysteel. China Domestic HCC Price is Liulin #4 price sourced from Sxcoal and is normalized to CFR China equivalent. Seaborne HCC Price (CFR China) is based on Argus Premium HCC CFR China. Plotted to April 16, 2021.

Slide 134: Chinese Scrap Use Remains Low

1. Source: Bureau of International Recycling, BIR Global Facts and Figures, 11th Edition.
2. Source: Data compiled by Teck based on information from Bureau of International Recycling.
3. Source: Data compiled by Teck based on information from China Metallurgy Industry Planning and Research Institute.
4. Source: Data compiled by Teck based on information from Wood Mackenzie (Long Term Outlook H2 2020) and CRU (Crude Steel Market Outlook April 2021).

Endnotes: Steelmaking Coal Market

Slide 135: Steelmaking Coal Supply Growth Forecast

1. Source: Data compiled by Teck based on information from Wood Mackenzie (Short Term Outlook March 2021).

Slide 136: Australia and US Steelmaking Coal Exports

1. Source: Data compiled by Teck based on information from IHS Global Trade Atlas. 2021E is an annualized number based on the 2021 year to date actual.
2. Source: Data compiled by Teck based on information from T.Parker. 2021E is an annualized number based on the 2021 year to date actual.

Slide 137: Canadian & Mozambique Steelmaking Coal Exports

1. Source: Data compiled by Teck based on information from IHS Global Trade Atlas. 2021E is an annualized number based on the 2021 year to date actual.
2. Source: 2010-2021E numbers are based on information from Wood Mackenzie's Long Term Outlook H2 2020 and Short Term Outlook August 2021.

Steelmaking Coal Resilience

Teck



Executive Summary



Steel demand is forecast to remain strong through to 2050

- Steel is not substitutable for most applications
- Steel is required for infrastructure development, including that required to support electrification and decarbonization



Demand for high-quality seaborne hard coking coal used in blast furnace steelmaking is forecast to remain strong

- Forecast long-term demand for steel is strong in high growth importing regions such as India and South-East Asia where blast furnace steelmaking will dominate
- Teck's high-quality seaborne steelmaking coal will continue to be a key resource for the low-carbon transition



Global steel industry emits 7-10% of total GHG emissions

- Meeting the objective of the Paris Accord will rely on a range of steelmaking abatement technologies
- Together they can reduce steelmaking emissions by more than 80% by 2050



Blast furnace CCUS is the only technology capable of decarbonizing steelmaking at the rate and scale required by 2050

- >70% of the world's steelmaking uses blast furnaces
- Leverages sunk cost of more than US\$1 trillion of young blast furnaces, which will last well into the second half of this century
- Blast furnace CCUS is the only technology commercially ready for near-term adoption

Steel is Essential for Economic Growth In a Low-Carbon World



World's largest metal market today

Steel is **widely used** and **hard to substitute**

Growth continues to be driven by **decarbonization** and ongoing economic development

Global Production in 2019 (Mt)

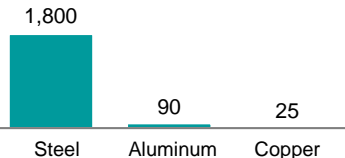

Enables low-carbon energy system

Fundamental to **renewable energy transition** and **1.5°C target** of Paris Accord

Steelmaking coal required while **alternatives evolve** and **carbon abatement policy advances**

~25%

Lower CO₂ footprint in steel relative to cement¹



Suited for a circular economy

Easily recyclable (e.g., without alloy issue of aluminum)

80%+ recycle rate of steel scrap in developed economies²

>90%

Lower CO₂ footprint of recycled steel compared to new steel¹



Essential to lifting global living standards

Middle class expected to grow by **2-3 billion people** by 2050, **mostly in India and South-East Asia (SEA)**

Rural communities are **moving to cities**, driving infrastructure build

~165%

Increase in combined annual demand growth for India and SEA³ between 2019 and 2050

Steel Demand Is Robust Through 2050

In all IEA Scenarios

Finished steel demand, billion tonnes

Standard Growth scenario – IEA SDS¹

- Industrialized growth in India and South East Asia
- China plateaus until 2030 before converging to Japan/Germany levels
- Growth in North America from green infrastructure development

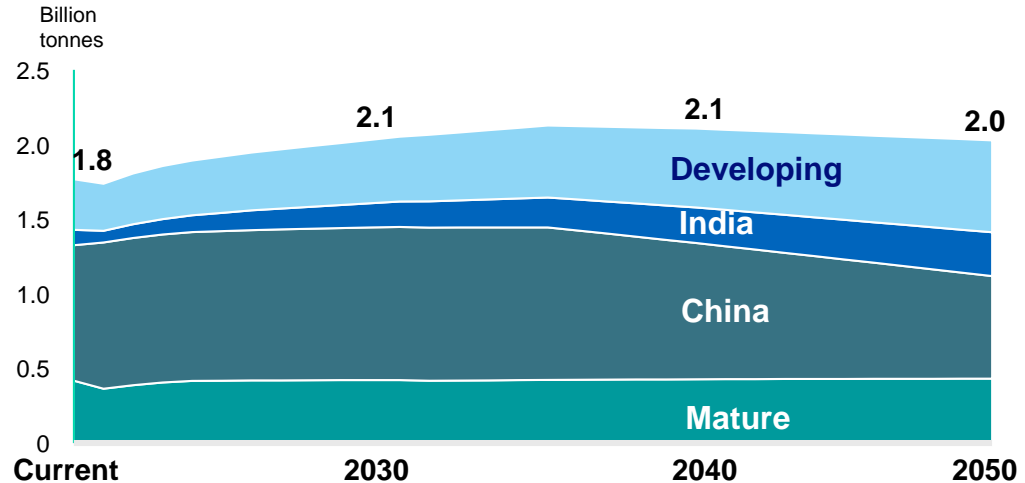

Robust Growth scenario – IEA STEPS²

- China grows for several more years and then joins developed Asian rate

Muted Growth scenario

- China decline to Western European levels by 2050

Blast Furnace + CCUS Will Lead Large-Scale Decarbonization Adoption

Blast Furnace + CCUS is adoption ready



Proven technology in hard-to-abate industries

- CCUS operates in power generation, refining, petrochemicals, agrichemicals, and steel/iron industry



Blast Furnace + CCUS is commercially feasible

- Leverages >US\$1 trillion of young installed blast furnace fleet
- Ample global CCUS storage capacity of ~5 trillion tonnes CO₂



Fastest path to large-scale decarbonization

- >75% of global steel is produced through the blast furnace route
- Requires moderate CO₂ pricing (> US\$50/t - \$150/t CO₂) to be economic
- Cost reductions achieved with generational learning



Accelerators to adoption

- Large-scale hub and cluster transportation and storage infrastructure will support economies of scale

Blast Furnace + CCUS adoption will lead through 2050²

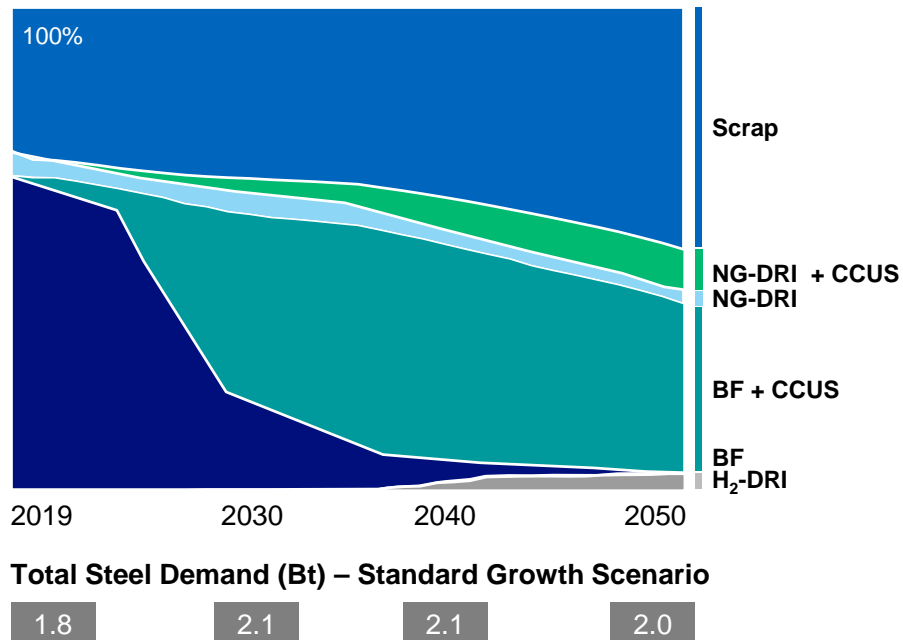

Blast Furnace + CCUS is the Only Technology That can be Adopted with Speed and Scale

Total Cost of Ownership¹ (US\$/t liquid steel)
China (SDS – 1.7° scenario)

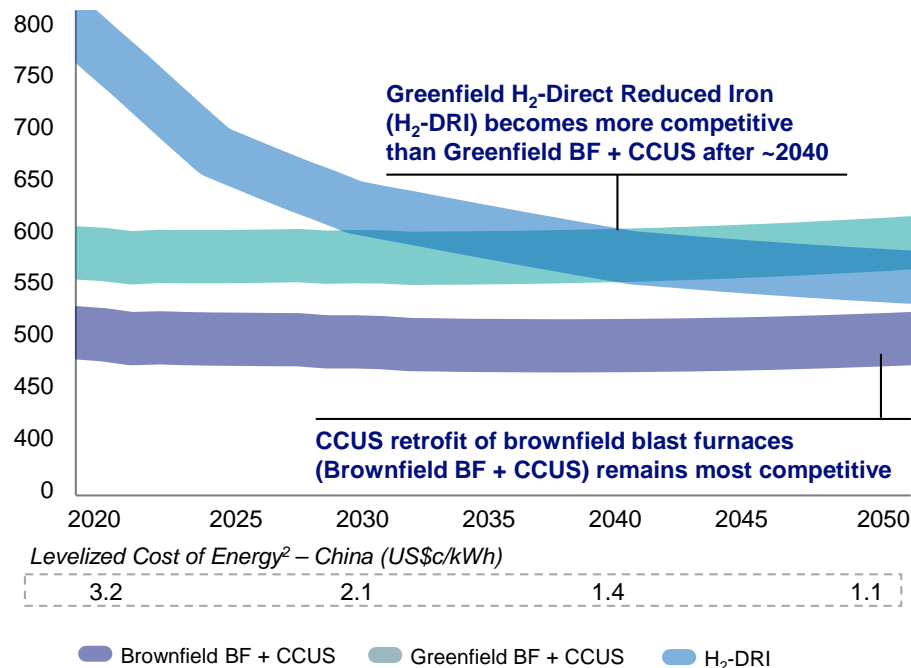

To make hydrogen steelmaking cost competitive, ample access to low-cost hydrogen (US\$1-2/kg) is required. This implies:

Stable supply of renewable power <US\$1.5c/KWh

- Significant investment in large-scale renewable infrastructure development that does not exist today
- ~60% lower wind and solar costs

Low-cost, highly-efficient electrolyzers

- Decline in electrolyzer capex by ~80%
- High-capacity scale-up and utilization rates
- Sufficient H₂ storage capacity to allow stable and continuous supply

High-grade iron ore pellet availability

- Availability constraints on high-grade iron-ore pellets suitable for DRI will limit H₂-DRI adoption beyond 2030

Large-scale green hydrogen adoption is unlikely before 2040

Despite Robust Steel Demand, Long-Term Demand for Steelmaking Coal Is Expected to Decline...

Steelmaking Coal Demand¹ (Mtpa)

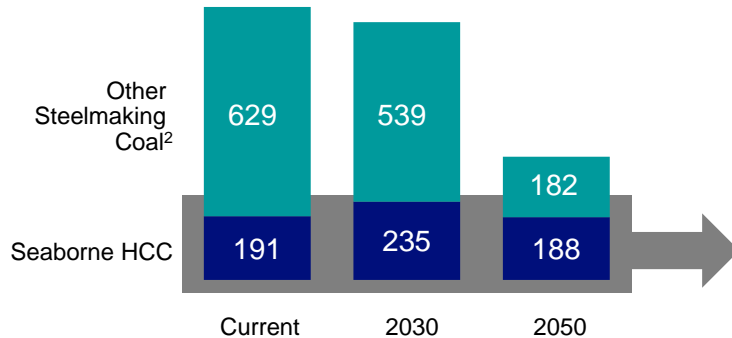

Global demand for non-seaborne hard coking coal is expected to decline by 2050 due to 3 factors:

1. **Increased steel scrap availability and recycling** in mature regions
2. **Declining coke rates** due to blast furnace efficiency gains, expected to erode some coking coal demand
3. **Ramp up of direct reduced iron (DRI) steelmaking using natural gas and hydrogen**, expected to displace some coking coal demand mainly after 2040

The magnitude of steelmaking coal demand will ultimately be driven by the pace of decarbonization

...But Long-Term Demand for Seaborne Hard Coking Coal Will Remain Robust

Seaborne Steelmaking Coal Demand¹ (Mtpa)

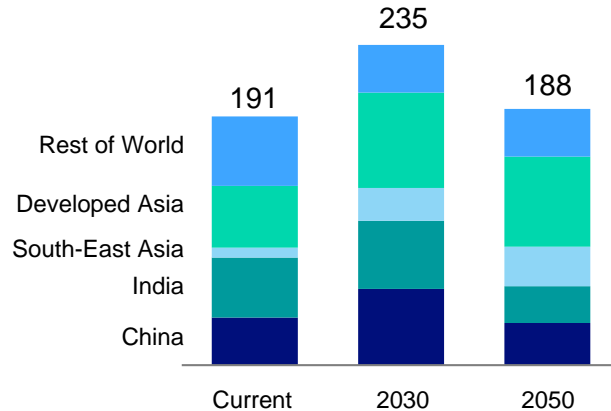

- **Seaborne HCC demand is** expected to remain resilient due to steel demand growth in regions that rely on lower-cost seaborne hard coking coal (HCC) imports (e.g., India and South-East Asia) for blast furnace steelmaking
- **Premium hard coking coal such as Teck's product** is expected to be favored as it improves blast furnace efficiency and lowers emissions

Seaborne hard coking coal demand will benefit from strong growth in major importing regions where blast furnace steelmaking will dominate

Blast Furnace Capacity Development is Well Underway in India and South-East Asia

- Asia committing to 20+ years of traditional steel making
- European steel mills seek alternatives to coal feed
- Hydrogen pilot plants only, commercial technology still decades away and currently prohibitively expensive
- Seek alternative carbon abatement in CCUS

Blast Furnace Capacity² (Mt)

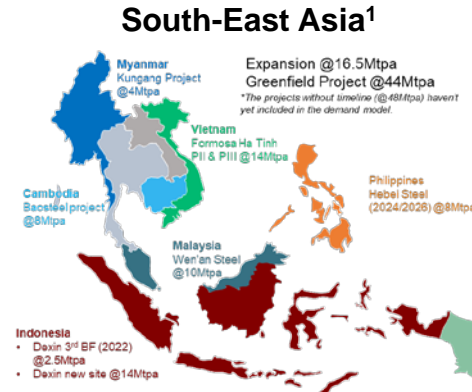
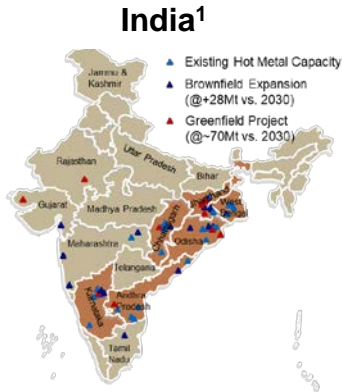
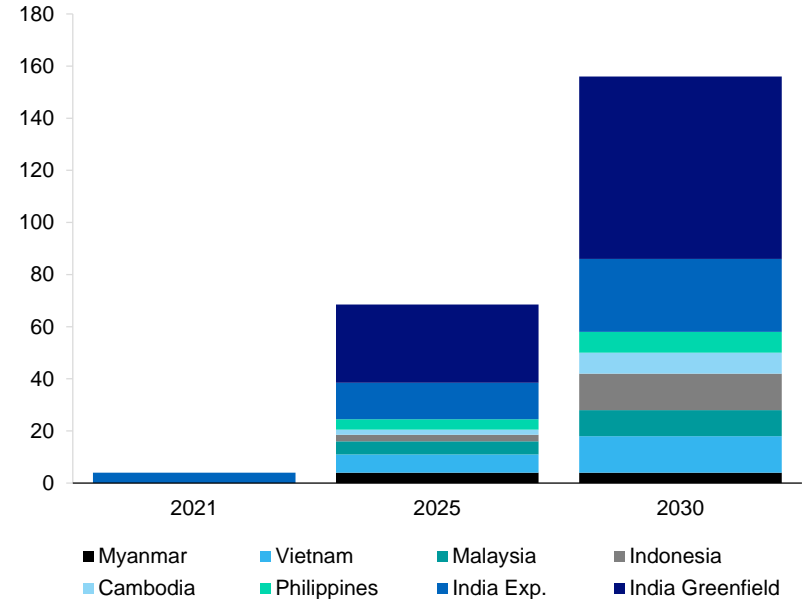

Financial commitments being made for multi-decade traditional steel making

Teck's Hard Coking Coal Is Optimally Positioned For a Decarbonizing Future

Teck's HCC has amongst lowest Scope 1 and Scope 2 emissions relative to peers

- Teck's emissions intensity is within the **lowest of the commodity range, assisted by access to low carbon sources of electricity in B.C.**
- Teck mines will be **even more cost competitive** with rising CO₂ prices globally

CO₂ Coal Intensity Curve¹
(t CO₂e/t saleable coal)

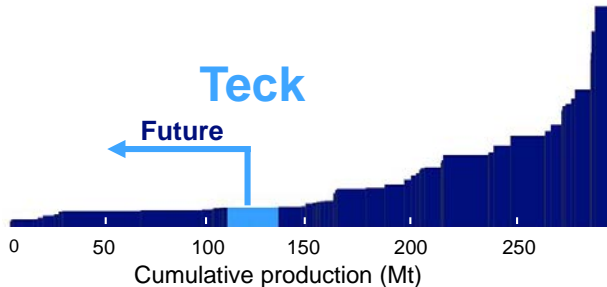

Highest quality HCC leading to lowest CO₂ emissions in steelmaking

- Teck premium HCC is **amongst the highest quality in the world, benchmarking favorably to premium Australian coking coal** on strength and volatility²
- Teck HCC **improves blast furnace efficiency** and **decreases CO₂ emissions per tonne of steel**



Globally advantaged seaborne logistics and cost position

- Proximity to the Pacific Ocean gives **direct access to Asia**
- By 2050, **forecast cost position in the 1st-2nd quartile** due to scarce new projects and high-cost for domestic suppliers switching to export

Simplified 2030 Seaborne HCC Supply Curve³

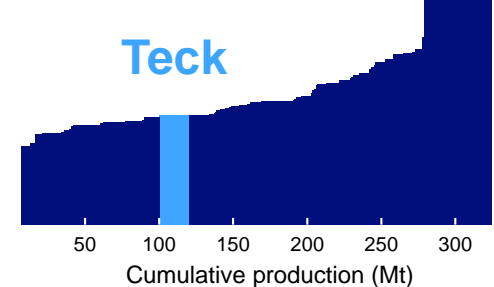

Endnotes: Steelmaking Coal Resilience

Slide 143: Steel is Essential for Economic Growth In a Low-Carbon World

1. Source: Teck.
2. Source: WSA, IEA.
3. India (from ~100 Mt in 2019 to 300 Mt in 2050) and South-East Asia (from ~100 Mt in 2019 to ~230 Mt in 2050) IEA SDS Scenario assumptions on CO2 pricing (~US\$0/t CO2 in 2020 to ~US\$160/t in 2050).

Slide 144: Steel Demand Is Robust Through 2050 in all IEA Scenarios

1. IEA Sustainable Development Scenario (SDS) +1.7C and internal analysis.
2. IEA Stated Policies Scenario and internal analysis.

Slide 145: Blast Furnace + CCUS Will Lead Large-Scale Decarbonization Adoption

1. Global CCUS Institute estimates.
2. IEA Sustainable Development Scenario (SDS) +1.7°C.

Slide 146: Blast Furnace + CCUS is the Only Technology That can be Adopted with Speed and Scale

1. IEA forecast and internal analysis, Sustainable Development Scenario (SDS) +1.7°C.
2. LCOE based on Solar PV.

Slide 147: Despite Robust Steel Demand, Long-Term Demand for Steelmaking Coal Is Expected to Decline...

1. IEA Sustainable Development Scenario (SDS) +1.7°C.
2. Comprised of landborne hard coking coal and global semi-soft coking coal.

Slide 148: ...But Long-Term Demand for Seaborne Hard Coking Coal Will Remain Robust

1. IEA Sustainable Development Scenario (SDS) +1.7°C.

Slide 149: Blast Furnace Capacity Development is Well Underway in India and South-East Asia

1. Announced planned blast furnace expansions and greenfield blast furnaces projects, various company announcements.
2. Announced potential blast furnace capacity increases by country. Source: Various Company Announcements, Wood Mackenzie, CRU, Platts, Teck As at September 15, 2021.

Slide 150: Teck's Seaborne Steelmaking Coal Is Optimally Positioned For a Decarbonizing Future

1. Source: Skarn Associates, 2019.
2. Source: Coking coal peers company filings and presentations.
3. 2050 HCC operating cost, including royalty and price differential, \$/t, FOB, real 2020\$, MineSpans, 2021.

Energy Business Unit

Teck



Fort Hills Oil Sands Mine

State of the art oil sands mining facility

Capacity
200+kbpd
(Dec 2018)

Low GHG
Intensity²

High Ore Quality¹
(11.4% bitumen grade)

Long Life
Resource¹
(550Mbbbls Teck share)

Fort Hills Operations Update

Operational problems being addressed, with continued focus on production ramp-up

- Mining contractors now on site to support ramp-up
- Major water inflows are capped
- Process underway to stabilize and maintain pit wall slope
- Recent operational performance show clear signs of improvements in mine productivity



Focus on transforming Fort Hills into a Best-in-Class¹ mineable oil sands asset

Fort Hills Financial Outlook

Financial performance improves once production is stabilized

Assumptions

	2021	Fort Hills Potential
NYMEX WTI	US\$67.93	US\$75.00
WTI-WCS differential	US\$13.01	US\$12.00
C\$/US\$ exchange rate	1.24	1.25
Production – barrels/day ¹	20,045	41,330
Adjusted operating costs ²	C\$43/bbl	C\$23/bbl

EBITDA³ – Teck's Share (C\$ million)

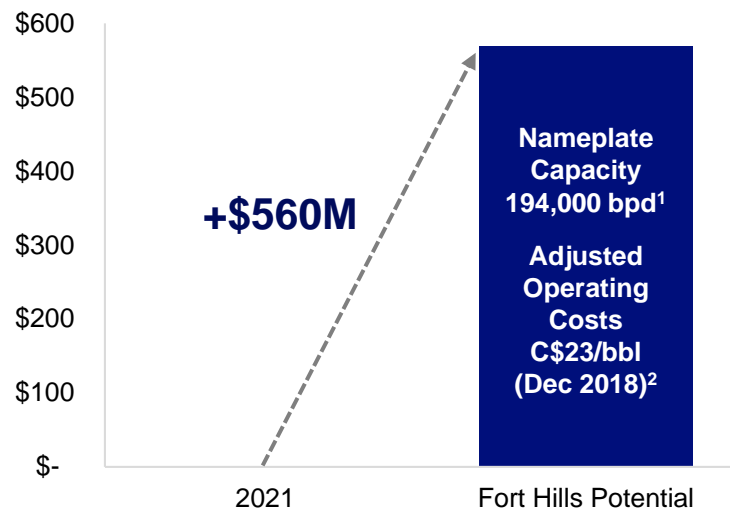

Improved financial performance expected with stable two-train production

Significant EBITDA Upside Potential

Providing the basis for strong and steady cash flow for decades

Assumptions

	WTI @ US\$75/BBL	WTI @ US\$60/BBL
WTI-WCS differential	US\$10.75	US\$10.75
C\$/US\$ exchange rate	1.25	1.25
Adjusted operating costs ²	C\$23/bbl	C\$23/bbl

- Debottlenecking could add incremental capacity of 20,000 – 40,000 barrels per day
- Regional synergies may provide further opportunities for cost efficiencies and production optimization

EBITDA¹ Potential – Teck’s Share (C\$ million)

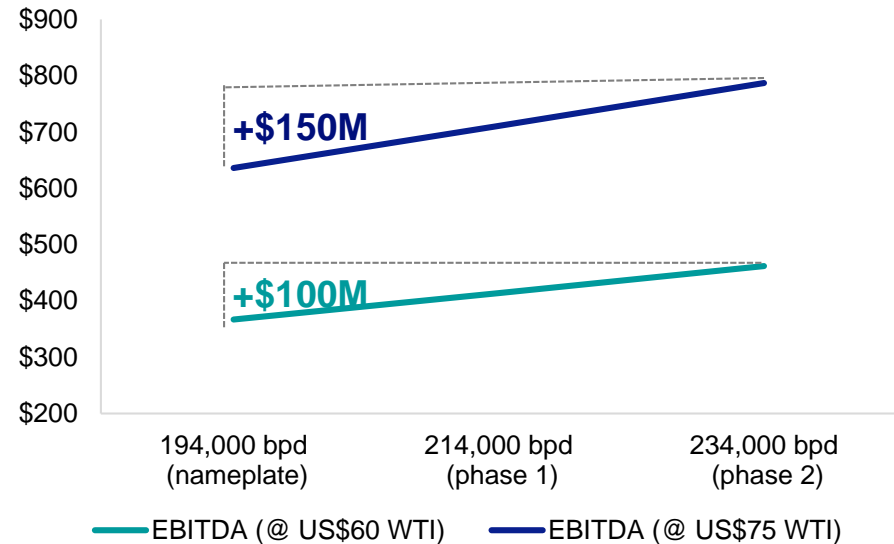

Potential annual EBITDA of \$300 million to \$700 million with debottlenecking

Best In Class Low Carbon Intensity Production

Our Fort Hills blend can displace carbon intensive crudes

- Emissions intensity of Canadian oil sands has declined by 25%; estimated reduction of 15% to 20% by 2030
- PFT bitumen emissions from mining significantly lower than others
- Fort Hills PFT currently the new bar for low emissions
- Fort Hills will displace barrels of crude from higher emitters

Total Life Cycle Emissions Intensity (kg CO₂e/bbl refined product – gasoline/diesel)

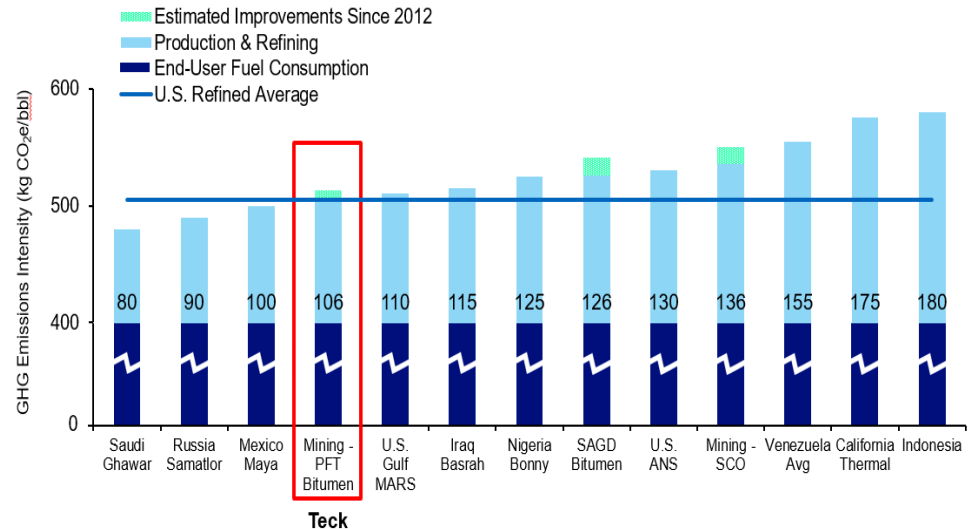

Source: Bloomberg, BMO Capital Markets

Lower carbon intensity than 50% of the US refined barrels of oil

Endnotes: Energy Business Unit

Slide 153: Fort Hills Oil Sands Mine

1. Source: Oil Sands Magazine. <https://www.oilsandsmagazine.com/projects/suncor-fort-hills-mine>
2. Source: Oil Sands Magazine. <https://www.canadianenergycentre.ca/this-oil-sands-crude-has-lower-ghg-emissions-than-the-u-s-average/>

Slide 154: Fort Hills Operations Update

1. Best-in-class (BIC) defined as >90% mine and plant availability and a competitive cost structure of <\$23 per barrel.

Slide 155: Fort Hills Financial Outlook

1. Short-term outlook assumes production at nameplate capacity of 194,000 barrels per day, equating to 41,330 barrels per day for Teck share.
2. Short-term outlook assumes Teck's actual adjusted operating costs of C\$22.48 per barrel in December 2018. Adjusted operating costs is a non-GAAP financial measure. See "Non-GAAP Financial Measures" slides.
3. EBITDA is a non-GAAP financial measure. See "Non-GAAP Financial Measures" slides.

Slide 156: Significant EBITDA Upside Potential

1. EBITDA is a non-GAAP financial measure. See "Non-GAAP Financial Measures" slides.
2. Adjusted operating costs is a non-GAAP financial measure. See "Non-GAAP Financial Measures" slides.

Slide 157: Best in Class Low Carbon Intensity Production

1. Bitumen production assumes the mid-point of our 2021 production guidance range.

Energy Market



Crude Oil Prices Supported by Supply Restraints

Demand-supply imbalance leading to price recovery

Demand returning to pre-COVID-19 levels

- Q4 2021 and 2022 annual forecast >100 Mbpd
- Prior to Hurricane Ida, US refinery capacity at 92%

Supply restraint – inventory drawdowns

- US: 1.5 Mbpd below peak
- OPEC+: Managed/ratable return to market

Canadian differentials steady; forecast to narrow on improved pipeline egress

- Enbridge Line 3: In-service Q4 2021
- TransMountain TMX: In service Q4 2022
- US/China/India largest heavy crude importers

Global Crude/Liquids Demand/Supply (Mbpd)

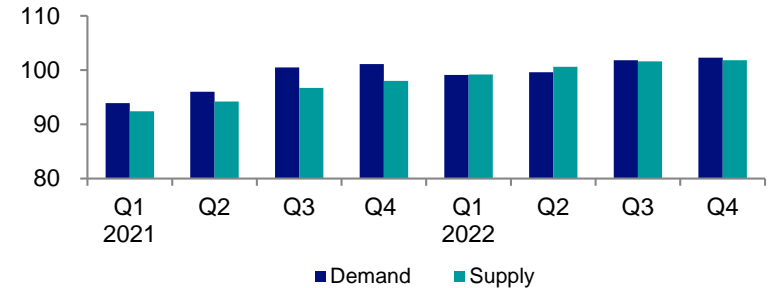

Benchmark Pricing (US\$/bbl)

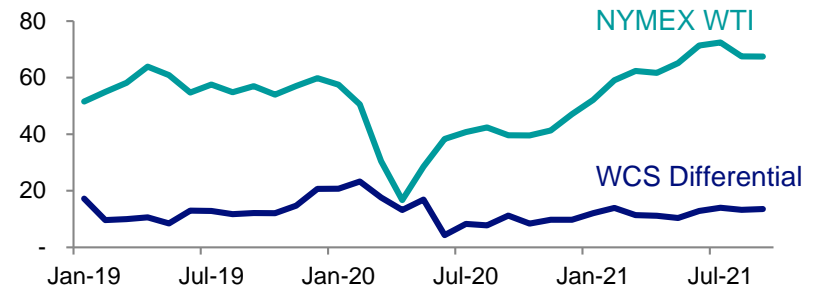

Non-GAAP Financial Measures

Teck



Non-GAAP Financial Measures

Our financial results are prepared in accordance with International Financial Reporting Standards (IFRS) as issued by the International Accounting Standards Board. This document refers to a number of Non-GAAP Financial Measures which are not measures recognized under IFRS and do not have a standardized meaning prescribed by IFRS or Generally Accepted Accounting Principles (GAAP) in the United States.

The Non-GAAP Measures described below do not have standardized meanings under IFRS, may differ from those used by other issuers, and may not be comparable to such measures as reported by others. These measures have been derived from our financial statements and applied on a consistent basis as appropriate. We disclose these measures because we believe they assist readers in understanding the results of our operations and financial position and are meant to provide further information about our financial results to investors. These measures should not be considered in isolation or used in substitute for other measures of performance prepared in accordance with IFRS.

Adjusted profit attributable to shareholders – For adjusted profit, we adjust profit attributable to shareholders as reported to remove the after-tax effect of certain types of transactions that reflect measurement changes on our balance sheet or are not indicative of our normal operating activities. We believe adjusted profit helps us and readers better understand the results of our core operating activities and the ongoing cash generating potential of our business.

Adjusted basic earnings per share – Adjusted basic earnings per share is adjusted profit divided by average number of shares outstanding in the period.

Adjusted diluted earnings per share – Adjusted diluted earnings per share is adjusted profit divided by average number of fully diluted shares in a period.

EBITDA – EBITDA is profit before net finance expense, provision for income taxes, and depreciation and amortization.

Adjusted EBITDA – Adjusted EBITDA is EBITDA before the pre-tax effect of the adjustments that we make to adjusted profit attributable to shareholders as described above.

Impairment adjusted EBITDA - Impairment adjusted EBITDA margin is EBITDA margin after impairments net of impairment reversal.

EBITDA margin – EBITDA margin is EBITDA as a percentage of revenue.

Impairment adjusted EBITDA margin - Impairment adjusted EBITDA margin is EBITDA margin after impairments net of impairment reversal.

The adjustments described above to profit attributable to shareholders and EBITDA highlight items and allow us and readers to analyze the rest of our results more clearly. We believe that disclosing these measures assists readers in understanding the ongoing cash generating potential of our business in order to provide liquidity to fund working capital needs, service outstanding debt, fund future capital expenditures and investment opportunities, and pay dividends.

Gross profit before depreciation and amortization – Gross profit before depreciation and amortization is gross profit with the depreciation and amortization expense added back. We believe this measure assists us and readers to assess our ability to generate cash flow from our business units or operations.

Gross profit margins before depreciation and amortization – Gross profit margins before depreciation are gross profit before depreciation and amortization, divided by revenue for each respective business unit or operation. We believe this measure assists us and readers to compare margins on a percentage basis among our business units. All operations in the Copper BU are mining operations. Mining operations in the Zinc BU are Red Dog and Pend Oreille.

Unit costs – Unit costs for our steelmaking coal operations are total cost of goods sold, divided by tonnes sold in the period, excluding depreciation and amortization charges. We include this information as it is frequently requested by investors and investment analysts who use it to assess our cost structure and margins and compare it to similar information provided by many companies in the industry.

Adjusted site cash cost of sales – Adjusted site cash cost of sales for our steelmaking coal operations is defined as the cost of the product as it leaves the mine excluding depreciation and amortization charges, out-bound transportation costs and any one-time collective agreement charges and inventory write-down provisions.

Total cash unit costs – Total cash unit costs for our copper and zinc operations includes adjusted cash costs of sales, as described above, plus the smelter and refining charges added back in determining adjusted revenue. This presentation allows a comparison of total cash unit costs, including smelter charges, to the underlying price of copper or zinc in order to assess the margin for the mine on a per unit basis.

Net cash unit costs – Net cash unit costs of principal product, after deducting co-product and by-product margins, are also a common industry measure. By deducting the co- and by-product margin per unit of the principal product, the margin for the mine on a per unit basis may be presented in a single metric for comparison to other operations. Readers should be aware that this metric, by excluding certain items and reclassifying cost and revenue items, distorts our actual production costs as determined under IFRS.

Non-GAAP Financial Measures

Adjusted cash cost of sales – Adjusted cash cost of sales for our copper and zinc operations is defined as the cost of the product delivered to the port of shipment, excluding depreciation and amortization charges, any one-time collective agreement charges or inventory write-down provisions and by-product cost of sales. It is common practice in the industry to exclude depreciation and amortization as these costs are non-cash and discounted cash flow valuation models used in the industry substitute expectations of future capital spending for these amounts.

Adjusted operating costs – Adjusted operating costs for our energy business unit is defined as the costs of product as it leaves the mine, excluding depreciation and amortization charges, cost of diluent for blending to transport our bitumen by pipeline, cost of non-proprietary product purchased and transportation costs of our product and non-proprietary product and any one-time collective agreement charges or inventory write-down provisions.

Cash margins for by-products – Cash margins for by-products is revenue from by- and co-products, less any associated cost of sales of the by and co-product. In addition, for our copper operations, by-product cost of sales also includes cost recoveries associated with our streaming transactions.

Adjusted revenue – Adjusted revenue for our copper and zinc operations excludes the revenue from co-products and by-products, but adds back the processing and refining charges to arrive at the value of the underlying payable pounds of copper and zinc. Readers may compare this on a per unit basis with the price of copper and zinc on the LME.

Adjusted revenue for our energy business unit excludes the cost of diluent for blending and non-proprietary product revenues, but adds back crown royalties to arrive at the value of the underlying bitumen.

Blended bitumen revenue – Blended bitumen revenue is revenue as reported for our energy business unit, but excludes non-proprietary product revenue, and adds back crown royalties that are deducted from revenue.

Blended bitumen price realized – Blended bitumen price realized is blended bitumen revenue divided by blended bitumen barrels sold in the period.

Operating netback – Operating netbacks per barrel in our energy business unit are calculated as blended bitumen sales revenue net of diluent expenses (also referred to as bitumen price realized), less crown royalties, transportation and operating expenses divided by barrels of bitumen sold. We include this information as investors and investment analysts use it to measure our profitability on a per barrel basis and compare it to similar information provided by other companies in the oil sands industry.

The debt-related measures outlined below are disclosed as we believe they provide readers with information that allows them to assess our credit capacity and the ability to meet our short and long-term financial obligations.

Net debt – Net debt is total debt, less cash and cash equivalents.

Debt to debt-plus-equity ratio – debt to debt-plus-equity ratio takes total debt as reported and divides that by the sum of total debt plus total equity, expressed as a percentage.

Net debt to net debt-plus-equity ratio – net debt to net debt-plus-equity ratio is net debt divided by the sum of net debt plus total equity, expressed as a percentage.

Debt to Adjusted EBITDA ratio – debt to adjusted EBITDA ratio takes total debt as reported and divides that by adjusted EBITDA for the twelve months ended at the reporting period, expressed as the number of times adjusted EBITDA needs to be earned to repay all of the outstanding debt.

Net debt to Adjusted EBITDA ratio – net debt to adjusted EBITDA ratio is the same calculation as the debt to adjusted EBITDA ratio, but using net debt as the numerator.

Net debt to capitalization ratio – net debt to capitalization ratio is net debt divided by the sum of total debt plus equity attributable to shareholders. The ratio is a financial covenant under our revolving credit facility.

Non-GAAP Financial Measures

Reconciliation of Profit (Loss) and Adjusted Profit

(CAD\$ in millions)	Three months ended June 30,		Six months ended June 30,	
	2021	2020	2021	2020
Profit (loss) attributable to shareholders	\$ 260	\$ (149)	565	\$ (461)
Add (deduct) on an after-tax basis:				
Asset impairment	—	—	—	474
COVID-19 costs	—	147	—	169
Environmental costs	44	69	11	(18)
Inventory write-downs (reversals)	—	38	(6)	65
Share-based compensation	24	17	34	(5)
Commodity derivatives	(20)	(20)	(5)	(5)
Taxes and other	31	(13)	66	(36)
Adjusted profit attributable to shareholders	\$ 339	\$ 89	665	\$ 183
Adjusted basic earnings per share	\$ 0.64	\$ 0.17	1.25	\$ 0.34
Adjusted diluted earnings per share	\$ 0.63	\$ 0.17	1.23	\$ 0.34

Non-GAAP Financial Measures

Reconciliation of Basic Earnings (Loss) Per Share to Adjusted Basic Earnings (Loss) Per Share and Reconciliation of Diluted Earnings (Loss) Per Share to Adjusted Diluted Earnings Per Share

(Per share amounts)	Three months ended June 30,		Six months ended June 30,	
	2021	2020	2021	2020
Basic earnings (loss) per share	\$ 0.49	\$ (0.28)	\$ 1.06	\$ (0.86)
Add (deduct):				
Asset impairment	—	—	—	0.88
COVID-19 costs	—	0.28	—	0.31
Environmental costs	0.08	0.13	0.02	(0.03)
Inventory write-downs (reversals)	—	0.07	(0.01)	0.12
Share-based compensation	0.05	0.03	0.06	(0.01)
Commodity derivatives	(0.04)	(0.04)	(0.01)	(0.01)
Other	0.06	(0.02)	0.13	(0.06)
Adjusted basic earnings per share	\$ 0.64	\$ 0.17	\$ 1.25	\$ 0.34

(Per share amounts)	Three months ended June 30,		Six months ended June 30,	
	2021	2020	2021	2020
Diluted earnings (loss) per share	\$ 0.48	\$ (0.28)	\$ 1.05	\$ (0.86)
Add (deduct):				
Asset impairment	—	—	—	0.88
COVID-19 costs	—	0.28	—	0.31
Environmental costs	0.08	0.13	0.02	(0.03)
Inventory write-downs (reversals)	—	0.07	(0.01)	0.12
Share-based compensation	0.04	0.03	0.06	(0.01)
Commodity derivatives	(0.04)	(0.04)	(0.01)	(0.01)
Other	0.07	(0.02)	0.12	(0.06)
Adjusted diluted earnings per share	\$ 0.63	\$ 0.17	\$ 1.23	\$ 0.34

Non-GAAP Financial Measures

Reconciliation of Net Debt to Adjusted EBITDA Ratio

	(A) Twelve months ended December 31, 2020	(B) Six Months ended June 30, 2020	(C) Six months ended June 30, 2021	(A-B+C) Twelve months ended June 30, 2021
Profit (loss)	\$ (944)	\$ (496)	\$ 552	\$ 104
Finance expense net of finance income	268	161	102	209
Provision for (recovery of) income taxes	(192)	(135)	418	361
Depreciation and amortization	1,510	692	748	1,566
EBITDA	\$ 642	\$ 222	\$ 1,820	\$ 2,240
Add (deduct):				
Asset impairment	1,244	647	—	597
COVID-19 costs	336	229	—	107
Environmental costs	270	(25)	15	310
Inventory write-down (reversals)	134	93	(10)	31
Share-based compensation	47	(7)	47	101
Commodity derivatives	(62)	(7)	(7)	(62)
Other	(41)	(59)	91	109
Adjusted EBITDA	\$ 2,570 (D)	\$ 1,093	\$ 1,956	\$ 3,433 (E)

	(A) Twelve months ended December 31, 2020	(B) Six Months ended June 30, 2020	(C) Six months ended June 30, 2021	(A-B+C) Twelve months ended June 30, 2021
Total debt at period end	\$ 6,947 (F)			\$ 7,892 (G)
Less: cash and cash equivalents at period end	(450)			(312)
Net debt	\$ 6,497 (H)			\$ 7,580 (I)
Debt to adjusted EBITDA ratio	2.7 (F/D)			2.3 (G/E)
Net Debt to adjusted EBITDA ratio	2.5 (H/D)			2.2 (I/E)
Equity attributable to shareholders of the company	20,039 (J)			20,557 (K)
Obligation to Neptune Bulk Terminals	138 (L)			158 (M)
Adjusted Net debt to capitalization ratio	0.24 (H+L)/(F+J+L)			0.27 (I+M)/(G+K+M)

Non-GAAP Financial Measures

Reconciliation of EBITDA and Adjusted EBITDA

(CAD\$ in millions)	Three months ended June 30.		Six months ended June 30.	
	2021	2020	2021	2020
Profit (loss)	\$ 260	\$ (185)	\$ 552	\$ (496)
Finance expense net of finance income	51	114	102	161
Provision for (recovery of) income taxes	209	(66)	418	(135)
Depreciation and amortization	370	314	748	692
EBITDA	890	177	1,820	222
Add (deduct):				
Asset impairment	—	—	—	647
COVID-19 costs	—	185	—	229
Environmental costs	61	96	15	(25)
Inventory write-downs (reversals)	—	57	(10)	93
Share-based compensation	33	23	47	(7)
Commodity derivatives	(27)	(28)	(7)	(7)
Taxes and other	32	(25)	91	(59)
Adjusted EBITDA	\$ 989	\$ 485	\$ 1,956	\$ 1,093

Non-GAAP Financial Measures

Reconciliation of Impairment Adjusted EBITDA and Impairment Adjusted EBITDA Margin

(C\$ in millions)	For the 12 Years Ending December 31, 2020
Steelmaking Coal	
Profit (loss) before taxes	\$ 15,847
Finance expense net of finance income	398
Depreciation and amortization	7,808
EBITDA	\$ 24,053
Impairments net of impairment reversal	2,114
Impairment Adjusted EBITDA (A)	\$ 26,167
Revenue (B)	\$ 54,047
Impairment Adjusted EBITDA Margin (A/B)	48%

Non-GAAP Financial Measures

Reconciliation of Gross Profit Before Depreciation and Amortization and Reconciliation of Gross Profit (Loss) Margins Before Depreciation

(CAD\$ in millions)	Three months ended June 30,		Six months ended June 30,	
	2021	2020	2021	2020
Gross profit	\$ 689	\$ 139	\$ 1,343	\$ 537
Depreciation and amortization	370	314	748	692
Gross profit before depreciation and amortization	\$ 1,059	\$ 453	\$ 2,091	\$ 1,229
Reported as:				
Copper				
Highland Valley Copper	\$ 194	\$ 93	\$ 396	\$ 170
Antamina	254	60	456	183
Carmen de Andacollo	59	16	106	76
Quebrada Blanca	11	4	22	7
Other	—	1	—	—
	518	174	980	436
Zinc				
Trail Operations	(3)	13	40	24
Red Dog	91	116	216	274
Other	8	3	11	17
	96	132	267	315
Steelmaking coal	457	220	869	641
Energy	(12)	(73)	(25)	(163)
Gross profit before depreciation and amortization	\$ 1,059	\$ 453	\$ 2,091	\$ 1,229

(CAD\$ in millions)	Three months ended June 30,		Six months ended June 30,	
	2021	2020	2021	2020
Revenues				
Copper (A)	\$ 821	\$ 405	\$ 1,588	\$ 975
Zinc (B)	461	479	1,031	1,087
Steelmaking coal (C)	1,112	792	2,159	1,815
Energy (D)	164	44	327	220
Total	\$ 2,558	\$ 1,720	\$ 5,105	\$ 4,097
Gross profit (loss), before depreciation and amortization				
Copper (E)	\$ 518	\$ 174	\$ 980	\$ 436
Zinc (F)	96	132	267	315
Steelmaking coal (G)	457	220	869	641
Energy (H)	(12)	(73)	(25)	(163)
Total	\$ 1,059	\$ 453	\$ 2,091	\$ 1,229
Gross profit margins before depreciation				
Copper (E/A)	63%	43%	62%	45%
Zinc (F/B)	21%	28%	26%	29%
Steelmaking coal (G/C)	41%	28%	40%	35%
Energy (H/D)	(7)%	(166)%	(8)%	(74)%

Non-GAAP Financial Measures

Copper Unit Cost Reconciliation

(CAD\$ in millions, except where noted)	Three months ended June 30,		Six months ended June 30,	
	2021	2020	2021	2020
Revenue as reported	\$ 821	\$ 405	\$ 1,588	\$ 975
By-product revenue (A)	(94)	(41)	(179)	(118)
Smelter processing charges (B)	28	27	58	64
Adjusted revenue	\$ 755	\$ 391	\$ 1,467	\$ 921
Cost of sales as reported	\$ 392	\$ 302	\$ 793	\$ 716
Less:				
Depreciation and amortization	(89)	(71)	(185)	(177)
By-product cost of sales (C)	(20)	(5)	(40)	(25)
Adjusted cash cost of sales (D)	\$ 283	\$ 226	\$ 568	\$ 514
Payable pounds sold (millions) (E)	140.7	116.4	284.1	272.2
Per unit amounts – CAD\$/pound				
Adjusted cash cost of sales (D/E)	\$ 2.01	\$ 1.94	\$ 2.00	\$ 1.89
Smelter processing charges (B/E)	0.20	0.23	0.20	0.23
Total cash unit costs – CAD\$/pound	\$ 2.21	\$ 2.17	\$ 2.20	\$ 2.12
Cash margin for by-products – ((A – C)/E)	(0.53)	(0.31)	(0.49)	(0.34)
Net cash unit costs – CAD\$/pound	\$ 1.68	\$ 1.86	\$ 1.71	\$ 1.78

(CAD\$ in millions, except where noted)	Three months ended June 30,		Six months ended June 30,	
	2021	2020	2021	2020
US\$ amounts¹				
Average exchange rate (CAD\$ per US\$1.00)	\$ 1.23	\$ 1.39	\$ 1.25	\$ 1.37
Per unit amounts – US\$/pound				
Adjusted cash cost of sales	\$ 1.64	\$ 1.40	\$ 1.61	\$ 1.39
Smelter processing charges	0.16	0.17	0.16	0.17
Total cash unit costs – US\$/pound	\$ 1.80	\$ 1.57	\$ 1.77	\$ 1.56
Cash margin for by-products	(0.43)	(0.22)	(0.39)	(0.25)
Net cash unit costs – US\$/pound	\$ 1.37	\$ 1.35	\$ 1.38	\$ 1.31

1. Average period exchange rates are used to convert to US\$ per pound equivalent.

We include unit cost information as it is frequently requested by investors and investment analysts who use it to assess our cost structure and margins and compare it to similar information provided by many companies in our industry.

Non-GAAP Financial Measures

Copper Unit Cost Reconciliation

(C\$ in millions, except where noted)	Three months ended December 31, 2020	Three months ended December 31, 2019	Year ended December 31, 2020	Year ended December 31, 2019
Revenue as reported	\$ 820	\$ 592	\$ 2,419	\$ 2,469
By-product revenue (A)	(104)	(68)	(300)	(311)
Smelter processing charges (B)	40	38	140	164
Adjusted revenue	\$ 756	\$ 562	\$ 2,259	\$ 2,322
Cost of sales as reported	\$ 452	\$ 462	\$ 1,560	\$ 1,852
Less:				
Depreciation and amortization	(102)	(109)	(383)	(463)
Inventory (write-downs) provision reversal	-	(20)	-	(24)
Labour settlement and strike costs	-	(22)	-	(35)
By-product cost of sales (C)	(29)	(19)	(71)	(58)
Adjusted cash cost of sales (D)	\$ 321	\$ 292	\$ 1,106	\$ 1,272
Payable pounds sold (millions) (E)	172.7	158.5	591.7	641.7
Per unit amounts (C\$/lb)				
Adjusted cash cost of sales (D/E)	\$ 1.86	\$ 1.84	\$ 1.87	\$ 1.98
Smelter processing charges (B/E)	0.23	0.24	0.23	0.26
Total cash unit costs (C\$/lb)	\$ 2.09	\$ 2.08	\$ 2.10	\$ 2.24
Cash margin for by-products (C\$/lb) ((A-C)/E)	(0.43)	(0.31)	(0.39)	(0.39)
Net cash unit costs (C\$/lb)	\$ 1.66	\$ 1.77	\$ 1.71	\$ 1.85
US\$ AMOUNTS¹				
Average exchange rate (C\$/US\$)	\$ 1.30	\$ 1.32	\$ 1.34	\$ 1.33
Per unit amounts (US\$/lb)				
Adjusted cash cost of sales	\$ 1.42	\$ 1.40	\$ 1.39	\$ 1.49
Smelter processing charges	0.18	0.18	0.18	0.19
Total cash unit costs (US\$/lb)	\$ 1.60	\$ 1.58	\$ 1.57	\$ 1.68
Cash margin for by-products (US\$/lb)	(0.33)	(0.24)	(0.29)	(0.29)
Net cash unit costs (US\$/lb)	\$ 1.27	\$ 1.34	\$ 1.28	\$ 1.39

1. Average period exchange rates are used to convert to US\$ per pound equivalent.

We include unit cost information as it is frequently requested by investors and investment analysts who use it to assess our cost structure and margins and compare it to similar information provided by many companies in our industry.

Non-GAAP Financial Measures

Zinc Unit Cost Reconciliation (Mining Operations)

(CAD\$ in millions, except where noted)	Three months ended June 30.		Six months ended June 30.	
	2021	2020	2021	2020
Revenue as reported	\$ 461	\$ 479	\$ 1,031	\$ 1,087
Less:				
Trail Operations revenues as reported	(465)	(395)	(926)	(847)
Other revenues as reported	(3)	(2)	(5)	(4)
Add back: Intra-segment revenues as reported	106	89	236	185
	\$ 99	\$ 171	\$ 336	\$ 421
By-product revenues (A)	—	(10)	(2)	(12)
Smelter processing charges (B)	28	53	103	130
Adjusted revenue	\$ 127	\$ 214	\$ 437	\$ 539
Cost of sales as reported	\$ 400	\$ 406	\$ 845	\$ 895
Less:				
Trail Operations cost of sales as reported	(489)	(405)	(928)	(868)
Other cost of sales as reported	5	1	6	13
Add back: Intra-segment purchases as reported	106	89	236	185
	\$ 22	\$ 91	\$ 159	\$ 225
Less:				
Depreciation and amortization	(14)	(36)	(39)	(78)
Royalty costs	19	6	(17)	(7)
By-product cost of sales (C)	—	(2)	—	(2)
Adjusted cash cost of sales (D)	\$ 27	\$ 59	\$ 103	\$ 138

(CAD\$ in millions, except where noted)	Three months ended June 30.		Six months ended June 30.	
	2021	2020	2021	2020
Payable pounds sold (millions) (E)	73.7	173.4	269.0	424.3
Per unit amounts – CAD\$/pound				
Adjusted cash cost of sales (D/E)	\$ 0.37	\$ 0.34	\$ 0.38	\$ 0.32
Smelter processing charges (B/E)	0.38	0.31	0.38	0.31
Total cash unit costs – CAD\$/pound	\$ 0.75	\$ 0.65	\$ 0.76	\$ 0.63
Cash margin for by-products – ((A - C)/E)	—	(0.05)	—	(0.02)
Net cash unit costs – CAD\$/pound	\$ 0.75	\$ 0.60	\$ 0.76	\$ 0.61
US\$ amounts²				
Average exchange rate (CAD\$ per US\$1.00)	\$ 1.23	\$ 1.39	\$ 1.25	\$ 1.37
Per unit amounts – US\$/pound				
Adjusted cash cost of sales	\$ 0.30	\$ 0.25	\$ 0.31	\$ 0.24
Smelter processing charges	0.31	0.22	0.31	0.22
Total cash unit costs – US\$/pound	\$ 0.61	\$ 0.47	\$ 0.62	\$ 0.46
Cash margin for by-products	—	(0.04)	—	(0.02)
Net cash unit costs – US\$/pound	\$ 0.61	\$ 0.43	\$ 0.62	\$ 0.44

1. Red Dog mining operations.

2. Average period exchange rates are used to convert to US\$ per tonne equivalent.

We include unit cost information as it is frequently requested by investors and investment analysts who use it to assess our cost structure and margins and compare it to similar information provided by many companies in our industry.

Non-GAAP Financial Measures

Steelmaking Coal Unit Cost Reconciliation

(CAD\$ in millions, except where noted)	Three months ended June 30,		Six months ended June 30,	
	2021	2020	2021	2020
Cost of sales as reported	\$ 879	\$ 734	\$ 1,730	\$ 1,511
Less:				
Transportation costs (A)	(258)	(197)	(514)	(439)
Depreciation and amortization	(224)	(162)	(440)	(337)
Inventory write-down reversal (B)	—	(32)	10	(27)
Labour settlement (C)	—	(4)	—	(4)
Adjusted site cash cost of sales (D)	\$ 397	\$ 339	\$ 786	\$ 704
Tonnes sold (millions) (E)	6.2	5.0	12.4	10.7
Per unit amounts – CAD\$/tonne				
Adjusted site cash cost of sales (D/E)	\$ 64	\$ 68	\$ 63	\$ 66
Transportation costs (A/E)	42	39	42	41
Inventory write-downs (B/E)	—	6	(1)	3
Labour settlement (C/E)	—	1	—	—
Unit costs – CAD\$/tonne	\$ 106	\$ 114	\$ 104	\$ 110
US\$ amounts¹				
Average exchange rate (CAD\$ per US\$1.00)	\$ 1.23	\$ 1.39	\$ 1.25	\$ 1.37
Per unit amounts – US\$/tonne				
Adjusted site cash cost of sales	\$ 52	\$ 49	\$ 51	\$ 48
Transportation costs	34	28	33	30
Inventory write-down reversal	—	5	(1)	2
Labour settlement	—	1	—	—
Unit costs – US\$/tonne	\$ 86	\$ 83	\$ 83	\$ 80

1. Average period exchange rates are used to convert to US\$ per tonne equivalent.

We include unit cost information as it is frequently requested by investors and investment analysts who use it to assess our cost structure and margins and compare it to similar information provided by many companies in our industry.

Non-GAAP Financial Measures

Energy Operating Netback, Bitumen & Blended Bitumen Price Realized Reconciliations and Adjusted Operating Costs and Adjusted Operating Costs¹

(CAD\$ in millions, except where noted)	Three months ended June 30.		Six months ended June 30.	
	2021	2020	2021	2020
Revenue as reported	\$ 164	\$ 44	\$ 327	\$ 220
Less:				
Cost of diluent for blending	(59)	(33)	(113)	(130)
Non-proprietary product revenue	(13)	(1)	(41)	(8)
Add back: crown royalties (D)	3	—	4	3
Adjusted revenue (A)	\$ 95	\$ 10	\$ 177	\$ 85
Cost of sales as reported	\$ 198	\$ 140	\$ 394	\$ 438
Less:				
Depreciation and amortization	(22)	(22)	(42)	(55)
Inventory write-down	—	(23)	—	(46)
Cash cost of sales	\$ 176	\$ 95	\$ 352	\$ 337
Less:				
Cost of diluent for blending	(59)	(33)	(113)	(130)
Cost of non-proprietary product purchased	(12)	(1)	(37)	(4)
Transportation for non-proprietary product purchased ³	(2)	(3)	(6)	(4)
Transportation for costs FRB (C)	(24)	(26)	(48)	(55)
Adjusted operating costs (E)	\$ 79	\$ 32	\$ 148	\$ 144

(CAD\$ in millions, except where noted)	Three months ended June 30.		Six months ended June 30.	
	2021	2020	2021	2020
Blended bitumen barrels sold (000's)	2,187	2,226	4,462	6,645
Less diluent barrels included in blended bitumen (000's)	(573)	(568)	(1,171)	(1,745)
Bitumen barrels sold (000's) (B)	1,614	1,658	3,291	4,900
Per barrel amounts – CAD\$				
Bitumen price realized (A/B)²	\$ 58.85	\$ 6.03	\$ 54.13	\$ 17.34
Crown royalties (D/B)	(1.69)	(0.10)	(1.28)	(0.64)
Transportation costs for FRB (C/B)	(14.67)	(16.01)	(14.59)	(11.24)
Adjusted operating costs (E/B)	(49.74)	(19.07)	(45.12)	(29.54)
Operating netback – CAD\$ per barrel	\$ (7.25)	\$ (29.15)	\$ (6.86)	\$ (24.08)

1. Calculated per unit amounts may differ due to rounding.

2. Bitumen price realized represents the realized petroleum revenue (blended bitumen sales revenue) net of diluent expense, expressed on a per barrel basis. Blended bitumen sales revenue represents revenue from our share of the heavy crude oil blend known as Fort Hills Reduced Carbon Life Cycle Dilbit Blend (FRB), sold at the Hardisty and U.S. Gulf Coast market hubs. FRB is comprised of bitumen produced from Fort Hills blended with purchased diluent. The cost of blending is affected by the amount of diluent required and the cost of purchasing, transporting and blending the diluent. A portion of diluent expense is effectively recovered in the sales price of the blended product. Diluent expense is also affected by Canadian and U.S. benchmark pricing and changes in the value of the Canadian dollar relative to the U.S. dollar.

Non-GAAP Financial Measures

Energy Operating Netback, Bitumen & Blended Bitumen Price Realized Reconciliations and Adjusted Operating Costs and Adjusted Operating Costs¹

(CAD\$ in millions, except where noted)	Three months ended June 30.		Six months ended June 30.	
	2021	2020	2021	2020
Revenue as reported	\$ 164	\$ 44	\$ 327	\$ 220
Less: non-proprietary product revenue	(13)	(1)	(41)	(8)
Add back: crown royalties	3	—	4	3
Blended bitumen revenue (A)	\$ 154	\$ 43	\$ 290	\$ 215
Blended bitumen barrels sold (000's) (B)	2,187	2,226	4,462	6,645
Blended bitumen price realized – (CAD\$/barrel) (A/B) = D ¹	\$ 70.23	\$ 19.30	\$ 65.15	\$ 32.32
Average exchange rate (CAD\$ per US\$1.00) (C)	1.23	1.39	1.25	1.37
Blended bitumen price realized – (US\$/barrel) (D/C)¹	\$ 57.18	\$ 13.93	\$ 52.24	\$ 23.67

3. Reflects adjustments for costs not directly attributed to the production of Fort Hills bitumen, including transportation for non-proprietary product purchased. We include unit cost information as it is frequently requested by investors and investment analysts who use it to assess our cost structure and margins and compare it to similar information provided by many companies in our industry.

Non-GAAP Financial Measures

Reconciliation of Free Cash Flow

(C\$ in millions)	2003 to Q2 2021
Cash Flow from Operations	\$49,310
Debt interest paid	(6,010)
Capital expenditures, including capitalized stripping costs	(30,828)
Payments to non-controlling interests (NCI)	(620)
Free Cash Flow	\$11,852
Dividends paid	\$4,540
Payout ratio	38%

Non-GAAP Financial Measures

Reconciliation of Gross Profit Before Depreciation & Amortization Margin from Mining Operations

(C\$ in millions, except where noted)	Year ended December 31, 2017	Year ended December 31, 2018	Year ended December 31, 2019	Year ended December 31, 2020	Six months ended June 30, 2021
Gross profit	\$ 4,567	\$ 4,621	\$ 3,340	\$ 1,333	\$ 1,343
Add back: Depreciation and amortization	1,492	1,483	1,619	1,510	748
Gross profit before depreciation and amortization	\$ 6,059	\$ 6,104	\$ 4,959	\$ 2,843	\$ 2,091
Revenues					
Copper	\$ 4,567	\$ 4,621	\$ 3,340	\$ 1,333	\$ 1,343
Zinc					
Trail	2,266	1,942	1,829	1,761	926
Red Dog	1,752	1,696	1,594	1,394	336
Pend Oreille	105	98	56	-	-
Other	8	8	8	9	5
Intra-segment revenues	(635)	(650)	(519)	(494)	(236)
	\$ 3,496	\$ 3,094	\$ 2,968	\$ 2,700	\$ 1,031
Steelmaking Coal	6,014	6,349	5,522	3,375	2,159
Energy	-	407	975	454	327
Total Revenues	\$ 11,910	\$ 12,564	\$ 11,934	\$ 8,948	\$ 5,105
Gross profit (loss) before depreciation and amortization					
Copper	\$ 1,154	\$ 1,355	\$ 1,080	\$ 1,242	\$ 980
Zinc					
Trail	209	91	-	65	40
Red Dog	971	990	837	717	216
Pend Oreille	19	(5)	(4)	-	-
Other	(26)	9	(2)	33	11
Intra-segment revenues	-	-	-	-	-
	\$ 1,173	1,085	\$ 831	\$ 815	\$ 267
Steelmaking Coal	3,732	3,770	2,904	1,009	869
Energy	-	(106)	144	(223)	(25)
Total gross profit (loss) before depreciation and amortization	\$ 6,059	\$ 6,104	\$ 4,959	\$ 2,843	\$ 2,091

Non-GAAP Financial Measures

Reconciliation of Gross Profit Before Depreciation & Amortization Margin from Mining Operations (cont.)

(C\$ in millions, except where noted)	Year ended December 31, 2017	Year ended December 31, 2018	Year ended December 31, 2019	Year ended December 31, 2020	Six months ended June 30, 2021
Gross profit (loss) margins before depreciation (%)					
Copper	48%	50%	44%	51%	62%
Zinc					
Trail	9%	5%	-	4%	4%
Red Dog	55%	58%	53%	51%	64%
Pend Oreille	18%	(5%)	(7%)	-	-
Other	(325%)	113%	(25%)	367%	220%
Intra-segment revenues	-	-	-	-	-
	34%	35%	28%	30%	26%
Steelmaking Coal	62%	59%	53%	30%	40%
Energy	-	(26%)	15%	(49%)	(8%)
Zinc Mining Assets					
Revenue					
Red Dog	\$ 1,752	\$ 1,696	\$ 1,594	\$ 1,394	\$ 336
Pend Oreille	105	98	56	-	-
	\$ 1,857	\$ 1,794	\$ 1,650	\$ 1,394	\$ 336
Gross profit (loss) before depreciation and amortization					
Red Dog	\$ 971	\$ 990	\$ 837	\$ 717	\$ 216
Pend Oreille	19	(5)	(4)	-	-
	\$ 990	\$ 985	\$ 833	\$ 717	\$ 216
Gross profit (loss) margins before depreciation and amortization	53%	55%	50%	51%	64%